



▶ TLM 193



Quick Guide
 Kurzanleitung
 Guide rapide
 Guida rapida
 Guia de inicio rápido
 Pikaohje
 Γρήγορος οδηγός
 Kısa Kılavuz
 Краткая инструкция

Guia rápido
 Beknopte handleiding
 Krótka instrukcja obsługi
 Snabbguide
 Kort vejledning
 快速指南
 クイックガイド
 퀵 가이드

PUBL. 06/18 - 575884/A01

TLM 193

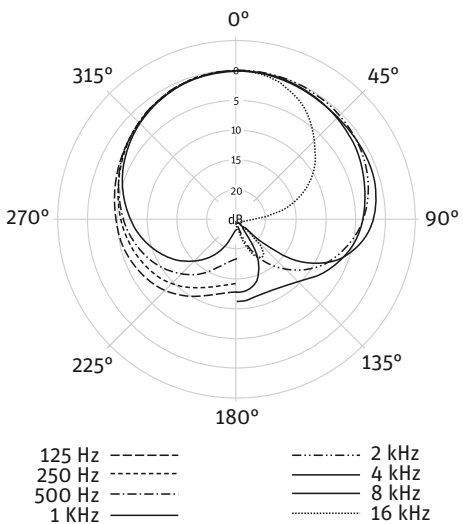
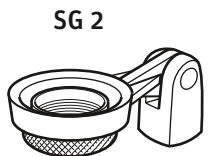

Specifications

Acoustic operating principle	Pressure gradient transducer
Directional pattern	Cardioid
Frequency range	20 Hz - 20 kHz
Sensitivity at 1 kHz into 1 kΩ	18 mV/Pa \cong -35 dBV \pm 1 dB
Rated impedance	50 Ω
Rated load impedance	1000 Ω
Signal-to-noise ratio, CCIR ¹⁾ (rel. 94 dB SPL)	73 dB
Signal-to-noise ratio, A-weighted ¹⁾ (rel. 94 dB SPL)	84 dB
Equivalent noise level, CCIR ¹⁾	21 dB
Equivalent noise level, A-weighted ¹⁾	10 dB-A
Maximum SPL for THD \leq 0.5% ²⁾	140 dB
Maximum output voltage	13 dBu
Supply voltage (P48, IEC 61938)	48 V \pm 4 V
Current consumption (P48, IEC 61938)	3 mA
Weight	480 g
Dimensions (diameter / length)	\varnothing 49 mm / 175 mm
Operating temperature range	0 °C - +70 °C (32 °F - 158 °F)
Storage temperature range	-20 °C - +70 °C (-4 °F - 158 °F)
Humidity range	max. 90 % at +20 °C

¹⁾ according to IEC 60268-1; CCIR-weighting according to CCIR 468-3, quasi peak; A-weighting according to IEC 61672-1, RMS
²⁾ measured as equivalent el. input signal



Instruction manual | Bedienungsanleitung | Notice d'emploi | Istruzioni per l'uso |
 Instrucciones de manejo | Manual de instruções | Gebruiksaanwijzing | Instrukcja
 obsługi | Bruksanvisning | Betjeningsvejledning | Käyttöohje | Οδηγίες
 λειτουργίας | Kullanım kılavuzu | Инструкция по эксплуатации | 使用说明书 |
 取扱説明書 | 사용 설명서 |

www.neumann.com -> TLM 193

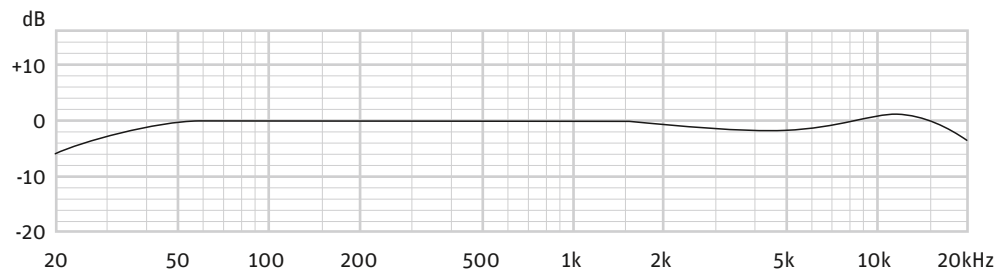

TLM 193 & SG 2

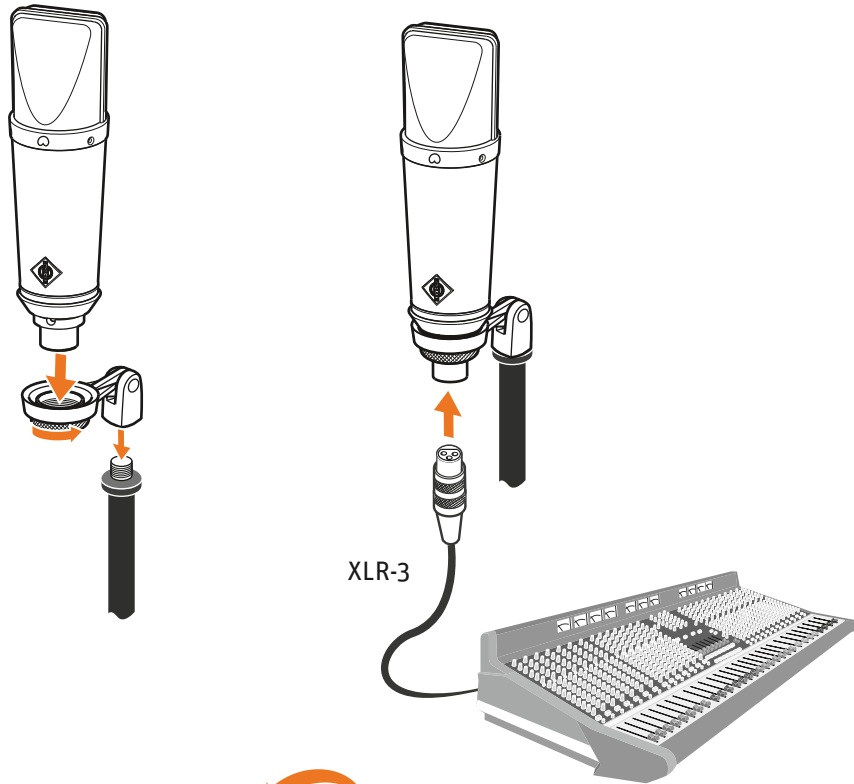

XLR-3

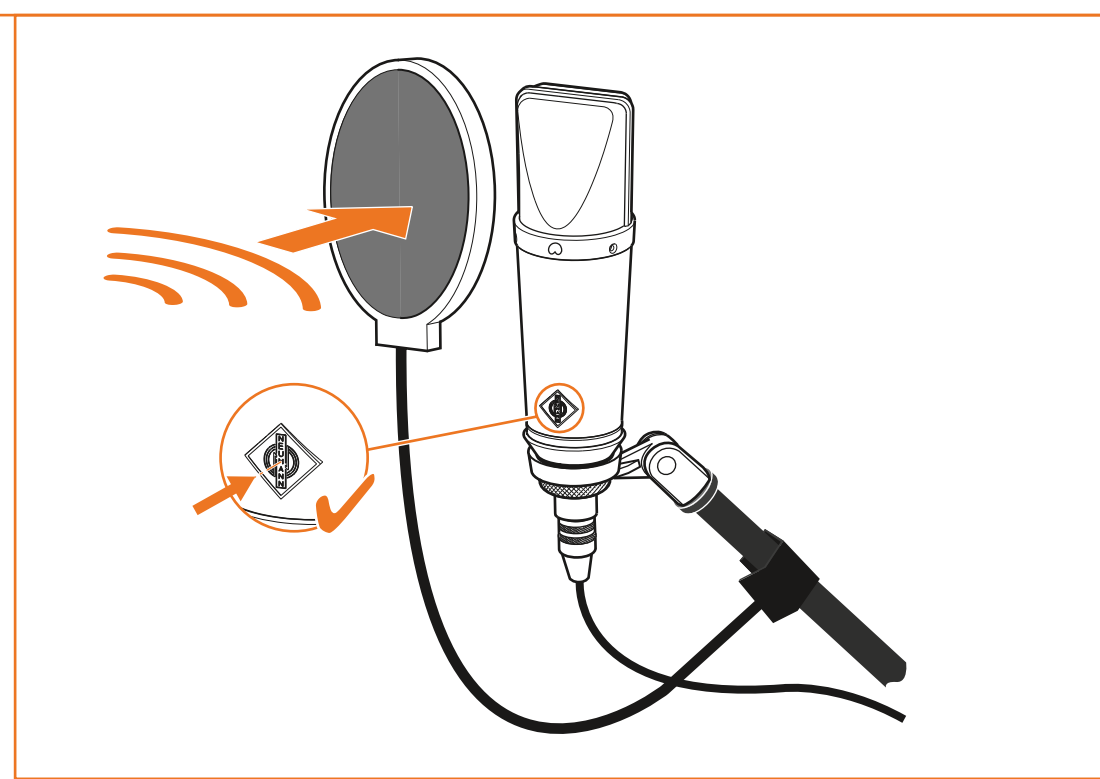
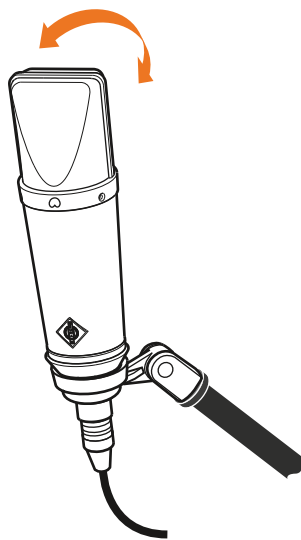

TLM 193 & EA 1*

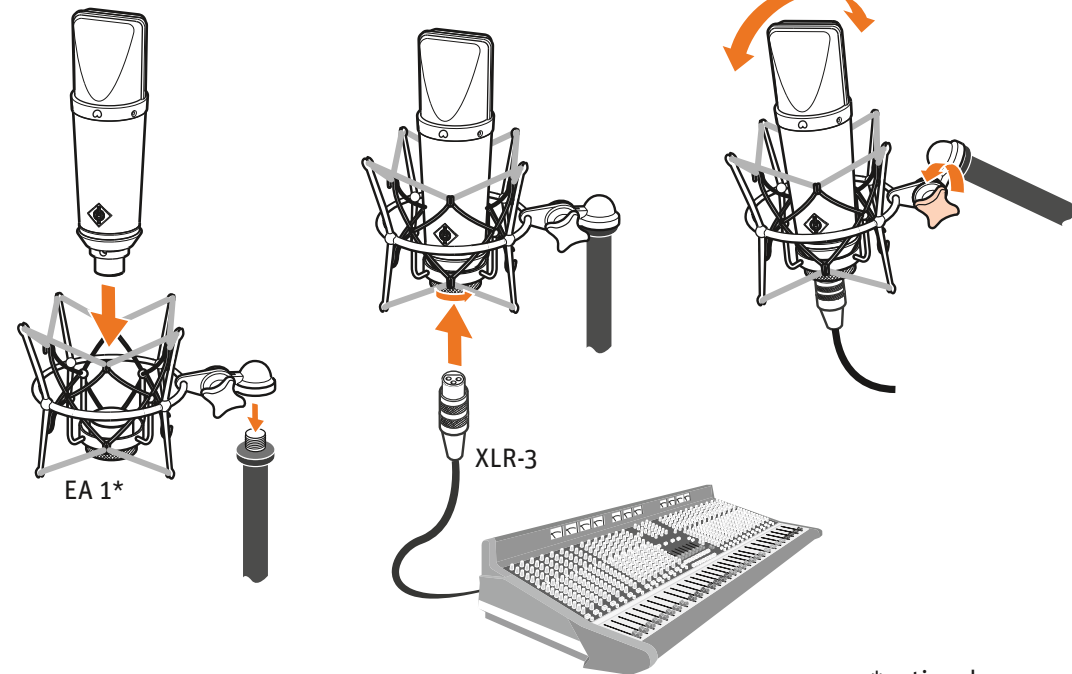

EA 1*

XLR-3

*optional accessory
(for details on further optional accessories see www.neumann.com)