

LA7.16

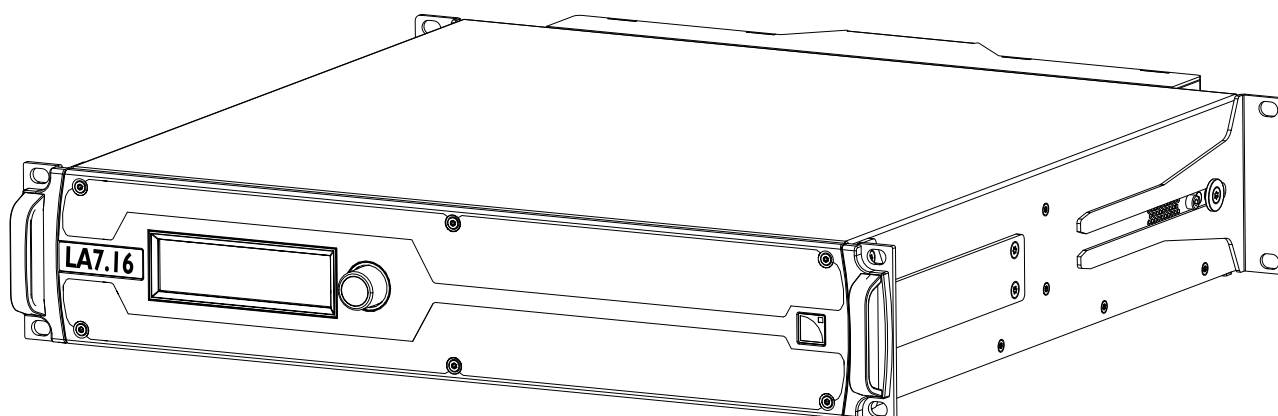

owner's manual (EN)



Document reference: LA7.16 owner's manual (EN) version 2.1

Distribution date: February 6, 2024

© 2024 L-Acoustics. All rights reserved.

No part of this publication may be reproduced or transmitted in any form or by any means without the express written consent of the publisher.

Contents











Safety.....	6
Important safety instructions.....	6
Symbols on the product.....	8
Introduction.....	9
How to use this manual.....	9
Revision history.....	10
System components.....	11
Technical description.....	13
Main features.....	13
Internal components.....	13
Front and rear panels.....	13
Signal processing and amplification.....	14
Signal inputs.....	14
DSP architecture.....	16
Power supply and amplifier section.....	17
Speaker outputs.....	17
Speaker protection.....	17
Monitoring and control.....	17
User interface.....	17
L-NET remote control network.....	17
Inspection and preventive maintenance.....	18
How to do preventive maintenance.....	18
CHK - External structure.....	19
CHK - Cleanness.....	20
CHK - Normal start-up sequence.....	20
CHK - Network functionalities and firmware.....	20
Installation.....	21
Mounting.....	21
Ventilation.....	22
General Purpose I/O (GPIO).....	22
Connecting to AC mains.....	23
Electrical specifications.....	23
Planning the power of the electrical generator.....	23
Power cord.....	24
Plugging the amplified controller.....	25

Power consumption.....	25
Heat power calculation.....	26
24 V DC Input.....	27
Audio and network cabling.....	27
Connection panels.....	27
Analog audio.....	30
Digital audio.....	31
L-NET/AVB.....	32
Speaker.....	34
Connector references.....	34
Operation.....	35
Powering on/off.....	35
Parameters accessible only from LA Network Manager.....	35
Using the interface.....	36
Editing gain or delay.....	37
Using the main screen.....	38
Layout name, type, and index.....	38
IP address.....	38
Outputs view.....	40
Inputs view.....	41
Using the input/output pages.....	43
Outputs.....	43
Inputs.....	45
Using the menu.....	49
Load user layout.....	49
Load factory layout.....	49
Store layout.....	49
Delete layout.....	50
Layout parameters.....	50
Clear group parameters.....	51
Media clock.....	52
AUX input settings.....	54
Monitoring & info.....	55
Event history.....	61
Options.....	62
IP settings.....	65
Standby.....	67
Identifying LA7.16.....	67
Specifications.....	68
General.....	68

Input signal distribution.....	70
Latency.....	70
Milan-AVB.....	70
Automatic fallback option.....	71
Remote control and monitoring.....	71
Physical data.....	71
Appendix A - Glossary.....	73
Appendix B - List of AVB reservation (RSV) errors.....	74
Appendix C - List of AVB connection (CON) errors.....	76
Appendix D - Approvals.....	77

Safety

Important safety instructions

- 
Inspect the product before operation.
 If any sign of defect or damage is detected, immediately withdraw the product from use for maintenance.
- 
Perform preventive maintenance at least once a year.
 Refer to the preventive maintenance section for a list of actions and their periodicity.
 Insufficient upkeep of the product can void the warranty.
- 
Verify the electrical conformity and compatibility of the mains supply.
 Only connect the product to an AC power outlet rated 100-240 V, 50-60 Hz, with the following current values:
 100-120 V: 30 A
 220-240 V: 16 A
 WARNING: The product is of Class 1 construction and shall be connected to a mains socket outlet with a Protective Earth connection.
- 
When the product is used in a three-phase circuit, verify the electrical conformity and compatibility of the three-phase circuit.
 Verify that the three phases work, and balance the loads between the three phases.
 Verify that the neutral and earth work.
 Never try to emulate a 230 V circuit connecting an apparatus to two live wires of a 120 V three-phase circuit.
 Never try to emulate a 200 V circuit connecting an apparatus to two live wires of a 100 V three-phase circuit.
- 
The power supply feeding LA7.16 must be equipped with circuit breakers meeting the following requirements:
 The circuit breaker must operate on each phase separately (no mechanical link between phases).
 Use these references, or equipment with equivalent characteristics:
 100-120 V: 30 A, Schneider Electric Square D 30A QO (in North America), or Mitsubishi CP30-BA-M (in Japan).
 220-240 V: 16 A, Type C.
 Circuit breakers of different characteristics could trip in case of short-term, high current draw, because they do not match LA7.16 Fuse Protect algorithms.
- 
Electrical generator
 You must power on the generator before powering on the product.
- 
Terminals marked with the lightning flash symbol are HAZARDOUS LIVE.
 The external wiring connected to these **terminals** requires installation by an **instructed person** or the use of ready-made leads or cords.
 Never attempt to touch any exposed speaker wiring while the product is operating: first disconnect the connector from the product.
 Mute all output channels before connecting a speaker to an amplified controller.
 Do not connect a speaker output in parallel or series with any output of another amplified controller.
 Do not connect the speaker outputs to any other voltage source, such as a battery, power mains, or power supply, regardless of whether the amplified controller is turned on or off.
- 
- 
Never incorporate equipment or accessories not approved by L-Acoustics.
- 
Read all the related PRODUCT INFORMATION documents shipped with the products before exploiting the system.
- 
Intended use
 This system is intended for use by trained personnel for professional applications.

 **As part of a continuous evolution of techniques and standards, L-Acoustics reserves the right to change the specifications of its products and the content of its documents without prior notice.**

Check www.l-acoustics.com on a regular basis to download the latest document and software updates.

 **Beware of sound levels.**

Do not stay within close proximity of loudspeakers in operation.

Loudspeaker systems are capable of producing very high sound pressure levels (SPL) which can instantaneously lead to permanent hearing damage to performers, production crew and audience members. Hearing damage can also occur at moderate level with prolonged exposure to sound.

Check the applicable laws and regulations relating to maximum sound levels and exposure times.

 **Beware of over power risks.**

Only use compatible loudspeakers with appropriate presets to avoid damage to the loudspeakers.

 **Do not use the product outside its operating temperature range.**

The product operates at a room temperature between -5 °C / 23 °F and 50 °C / 122 °F.

Do not expose the product to direct sun.

 **Do not expose the product to extreme conditions.**

Do not expose the product to moisture (rain, mist, sea spray, steam, humidity, condensation...) or excessive heat (direct sun, radiator...) for a long period of time.

For more information, refer to the **Products weather protection** document, available on the website.

 **Use the product in a conformed electro-magnetic environment.**

The product can be used in the following environment: non-residential (class A).

Avoid radio interference.

This product has been tested and complies with the regulations of the EMC directive (Electro Magnetic Compatibility). These regulations are designed to provide reasonable protection against harmful interference from electrical equipment, but it cannot be guaranteed that interference will never occur.

 **Product disconnection**

To completely disconnect this product from the mains, disconnect the power supply cord plug from the mains socket outlet.

 **Power supply cord and socket accessibility**

The main plug of the power supply cord shall remain easily accessible.

The mains socket outlet shall be easily accessible.

 **Read the maintenance section of this document before servicing the product.**

 **Contact L-Acoustics for advanced maintenance.**

Any unauthorized maintenance operation will void the product warranty.

Before sending a product to L-Acoustics for maintenance, save all user presets to files using LA Network Manager.

 **Shipping**

Use the original packaging for shipping the product, unless it is mounted in a rack with the front and rear panels fixed to the rack, as described in this manual.

Symbols on the product



Explanation of graphical symbols



The lightning flash with arrowhead symbol within an equilateral triangle is intended to alert the user to the presence of uninsulated "dangerous voltage" within the product's enclosure that may be of sufficient magnitude to constitute a risk of electric shock to persons.



The exclamation point within an equilateral triangle is intended to alert the user to the presence of important operating and maintenance instructions in the literature accompanying the product.



Do not open unless authorized. This symbol indicates the presence of electrical shock hazards. It also indicates that no maintenance performed by the end user requires access to internal components.



This marking indicates that this product should not be disposed of with other household waste throughout the EU. To prevent possible harm to the environment or human health from uncontrolled waste disposal, recycle it responsibly to promote the sustainable reuse of material resources. To return your used device, please use the return and collection systems or contact the retailer where the product was purchased. They can take this product for environmentally safe recycling.

Introduction

How to use this manual

The LA7.16 owner's manual is intended for all actors involved in the system design, implementation, preventive and corrective maintenance of the LA7.16 product. It must be used as follows:

1. Read the technical description for an overview of all product elements, their features, and their compatibilities.
 - [Technical description](#) (p.13)
2. Before installing the product, perform mandatory inspections and functional checks.
 - [Inspection and preventive maintenance](#) (p.18)
3. To deploy the product, follow the step-by-step installation instructions and refer to the cabling schemes.
 - [Installation](#) (p.21)
 - [Audio and network cabling](#) (p.27)
4. To configure the settings and parameters of the product, follow the step-by-step operation instructions.
 - [Operation](#) (p.35)

As part of a continuous evolution of techniques and standards, L-Acoustics reserves the right to change the specifications of its products and the content of its documents without prior notice.

Check www.l-acoustics.com on a regular basis to download the latest document and software updates.





Contact information

For information on advanced corrective maintenance:

- contact your Certified Provider or your L-Acoustics representative
- for Certified Providers, contact the L-Acoustics customer service: customer.service@l-acoustics.com (EMEA/APAC), laus.service@l-acoustics.com (Americas).

Symbols

The following symbols are used in this document:

-  This symbol indicates a potential risk of harm to an individual or damage to the product. It can also notify the user about instructions that must be strictly followed to ensure safe installation or operation of the product.
-  This symbol indicates a potential risk of electrical injury. It can also notify the user about instructions that must be strictly followed to ensure safe installation or operation of the product.
-  This symbol notifies the user about instructions that must be strictly followed to ensure proper installation or operation of the product.
-  This symbol notifies the user about complementary information or optional instructions.

Revision history

version number	publication date	modification
1.0	Jan. 2023	Initial version.
2.0	Jun. 2023	<ul style="list-style-type: none">• Added Media clock (p.52) menu.• Updated load LED threshold value. See Mute/load status (p.41).• Changed screen color in Identifying LA7.16 (p.67).• Updated instructions for setting a gateway IP address in IP settings (p.65).
2.1	Feb. 2024	Updated Power consumption (p.25).

System components

Powering and driving system

LA7.16 Amplified controller 16 × 1300 W / 8 ohms

Racks

LA-RAK III Touring rack containing three LA7.16, one LA-POWER II for power distribution, one LA-PANEL III for audio signal distribution, and two LS10 for AVB distribution

Cases

L-CASE II 2U electronics transport and protection case

Components

BOB32 Breakout box: SC32 to 2 × CA-COM + 8 × NL4

Cables

DOE cables Dual AVB Network cable CAT6A, etherCON (black = primary network, red = secondary network)
Come in different sizes: DOE2 (2 m / 6.6 ft), DOE45 (45 m / 147.6 ft), and DOE100 (100 m / 328.1 ft)

powerCON 32A Power supply cord with powerCON 32A connector (1.20 m / 3.9 ft).
Comes in different versions: EU, CN, INT, US.

SC32-4DO Breakout cable
SC32 connector to 4 × 8-point CA-COM

SC32 cables 16-channel loudspeaker cables for touring application (37-point female connector to 37-point male connector, 32 points used, 1.5 mm² gauge)
Come in different lengths: SC32-5 (5 m / 16.4 ft), SC32-10 (10 m / 32.8 ft), SC32-25 (25 m / 82 ft), SC32-50 (50 m / 164 ft)

Software applications

Soundvision 3D acoustical and mechanical modeling software

LA Network Manager Software for remote control and monitoring of amplified controllers



Refer to the Soundvision help.

Refer to the LA Network Manager help.

Loudspeaker enclosures



Refer to the user documentation of the loudspeaker systems for detailed instructions about the enclosures and their connection to the amplified controllers.

System component illustrations

Cables

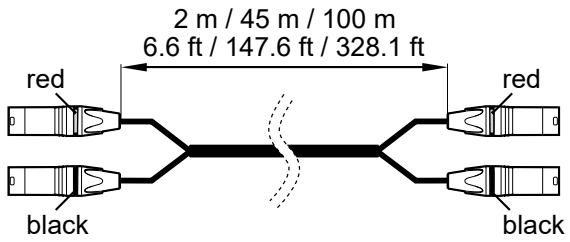

DOE cables

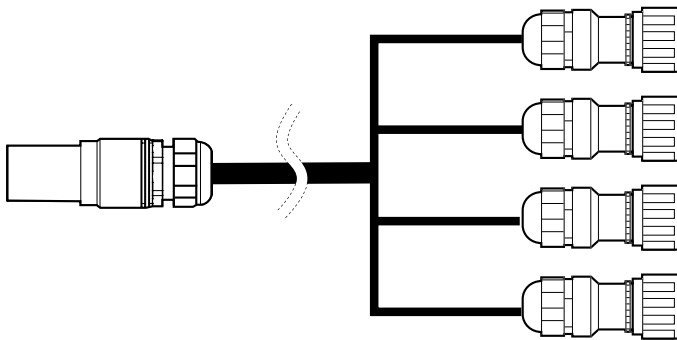

SC32-4DO

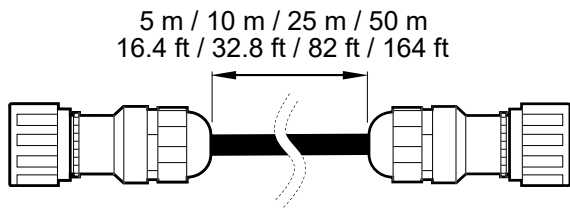

SC32 cables

Components

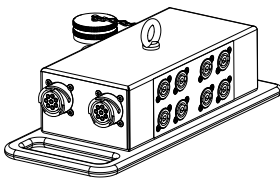

BOB32

Software applications

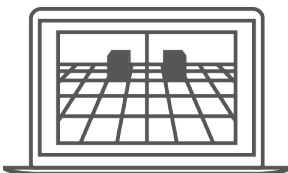

Soundvision



LA Network Manager

Technical description

Main features

Internal components

The core of the LA7.16 is a Gen. 5 dual DSP engine driving 16 channels of amplification from 16 AVB streams of up to eight channels, and one AES/EBU input (two channels) or one analog input (one channel). LA7.16 features a flash memory for preset storage and management, high performance A/D-D/A converters for audio signals, a universal Switched Mode Power Supply (SMPS) with PFC (Power Factor Correction), and a dual-port Ethernet Gigabit interface.

Front and rear panels

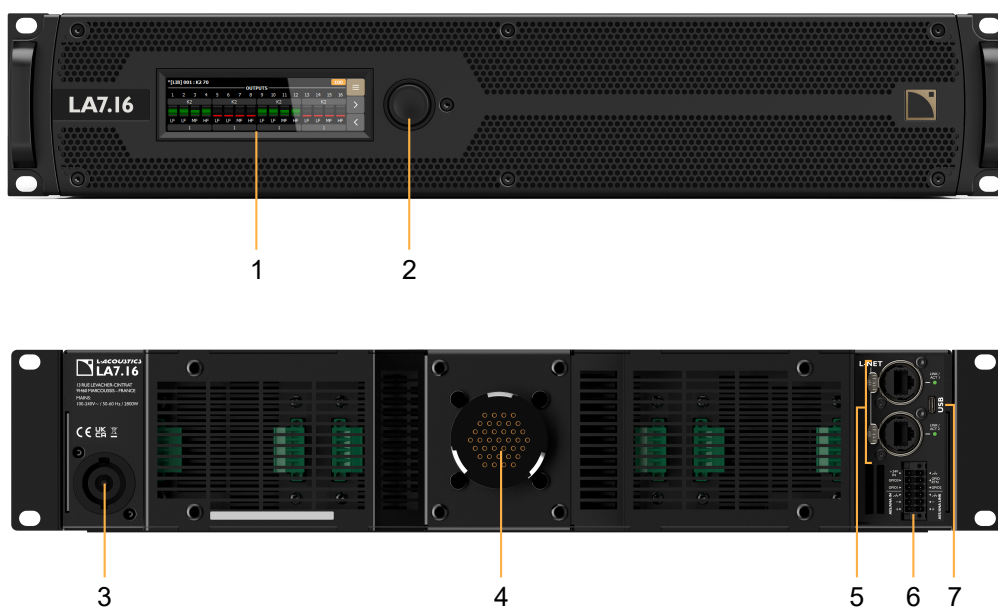

1. TFT color touchscreen display (480 × 128 px)
2. encoding wheel with push button
3. 1 × 32 A powerCON® connector
4. 1 × SC32 female connector
5. 2 × 1 Gb/s Ethernet etherCON® I/O connectors (top connector for primary network, bottom connector for secondary network)
6. 1 × 12-point terminal block that contains:
 - 1 × 24 V DC male to connect a backup power supply for the DSP
 - 1 ground pin
 - 3 General Purpose I/O (GPIO)
 - 1 ground GPIO pin
 - 1 AES/EBU input connector including:
 - 1 + signal pin
 - 1 - signal pin
 - 1 shield pin
 - 1 AES/EBU link connector including:
 - 1 + signal pin
 - 1 - signal pin
 - 1 shield pin
7. 1 Micro USB port for configuring IP settings. Refer to the **LA Network Manager** Help.

Signal processing and amplification

Signal inputs

LA7.16 features two 1 Gb/s Ethernet ports capable of receiving up to 128 channels from 16 AVB streams at 48 kHz or 96 kHz.

In addition, an AUX (auxiliary) input in either AES/EBU or Analog mode is available through the 12-point terminal block.

The AUX input source can be used as main input source, secondary input source, or fallback input source.

Refer to the **LA Network Manager** Help for more information.

Milan-AVB

LA7.16 can operate in normal network mode or in redundant network mode.

In both modes, 16 AVB streams of up to eight channels may be connected to LA7.16.

Each Ethernet port uses a high speed data transfer protocol up to 1 Gb/s and supports the IEC 61883-6 AM824 and AAF PCM32 stream formats with stream frequencies of 48 kHz or 96 kHz.

The amplified controller synchronizes its media clock according to the selection done by the user:

- internal clock generator
- one of the 16 AVB input streams
- the Media Clock stream in CRF format connected to its Media Clock input stream

The default selection is AVB input stream 1. When a CRF master media clock is available in the network, it is recommended to use it as clock source. LA7.16 features a CRF output stream that may be used as media clock master for the network.

In normal network mode, the Ethernet ports operate as part of an AVB bridge and may therefore be used to create an AVB network.

In redundant network mode, each port is dedicated to separate networks: first port for primary network, second port for secondary network.

Input channels can be freely assigned to the 16 amplification channels through flexible summing matrix.

AES/EBU

LA7.16 can be fed with one AES/EBU digital audio signal (containing two channels) using the 12-point terminal block (AES/ANA IN).

The audio signals can come from a digital mixing desk or from any audio device compliant with the AES/EBU (AES3) digital audio standards.

The input signals can be transmitted to daisy-chained amplified controllers using the 12-point terminal block (AES/ANA LINK).

The AES/EBU input port is equipped with an SRC (Sample Rate Converter) that has been selected to support a wide range of input formats (16 - 24 bits / 44.1 - 192 kHz). The SRC converts the formats to the 24 bits / 96 kHz internal format used by the amplified controller. The SRC is a high-quality hardware component (140 dB dynamic range, THD+N < -120 dBFS, strong input jitter attenuation) and provides constant propagation delay regardless of the input sampling frequency.

There is no AES/EBU external synchronization mode. The amplified controller's clock always runs at 96 kHz, referenced to the user-selected media clock: internal clock, AVB audio input stream, or CRF input stream. This ensures low jitter and high audio quality in live conditions (large cable lengths, large number of amplified controllers) while preventing phase shift, as required for line source systems.

Digital domain benefits

Keeping the signal in the digital domain provides the following benefits (with any digital mixing desk or any audio device) compared to the analog signal distribution:

- Better audio quality by removing one D/A - A/D cycle.
- Optimized level chain by removing the risk of level misalignment between console and amplified controllers.
- Digital signal refreshed at each amplified controller in a daisy-chain.

- Improved maximum cable length. LA7.16 has been tested with up to 300 m / 984 ft of two models of AES/EBU rated cables (single cuts, digital source signal running at $F_s = 48$ kHz):
 - 1696A from BELDEN INC.
 - OT234H from KLOTZ communications GmbH.

Analog

LA7.16 can be fed with one balanced analog audio signal using the 12-point terminal block (AES/ANA IN, AES/ANA LINK).

The input signal can be transmitted to daisy-chained amplified controllers using the 12-point terminal block (AES/ANA LINK).

To be processed by the DSP, the analog signal must be converted into a digital signal. For this purpose, the LA7.16 amplified controller is fitted with one 32-bit A/D converter with a sampling rate of 96 kHz, allowing an encoding dynamic range of 117 dB (A-weighted, 20 kHz bandwidth).

DSP architecture

The proprietary algorithms allow optimum performance and protection of each individual transducer of the L-Acoustics systems for an even more natural, transparent, and realistic sound experience.

- The DSP engine is a 32-bit floating point DSP at 96 kHz sampling rate providing an enhanced dynamic range since it does not generate calculation clips like a fixed point DSP.
- A dedicated engineering approach combining IIR and FIR filters generates perfectly linearized phase curves and significantly improved impulse responses.
- The 16 x 16 matrix architecture offers flexibility for various system configurations.
- A delay of up to 1000 ms can be set for each output channel.
- The L-DRIVE transducer protection system offers advanced protection by simultaneously monitoring the excursion and the temperature of the transducer.
- With a complete factory preset library and the possibility to create additional user presets, the flash memory provides a quick access to all the usual L-Acoustics speaker system configurations (refer to the **Preset Guide**).

audio path parameters

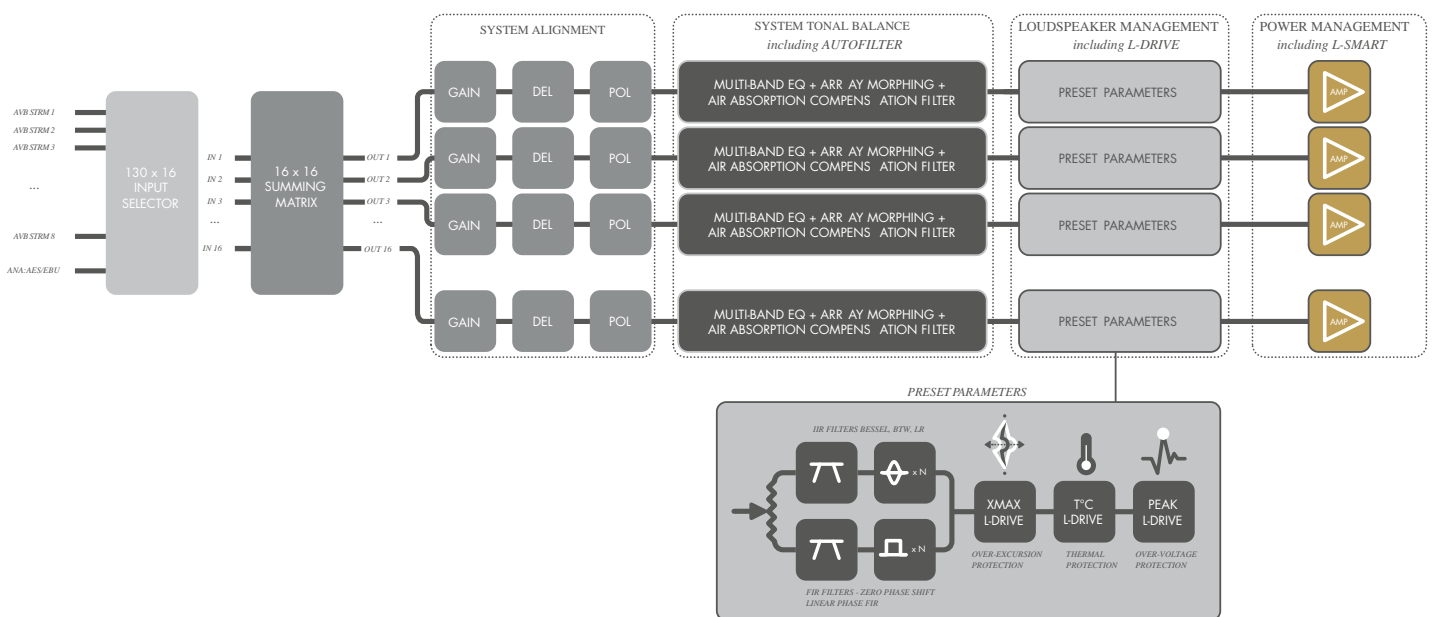

Power supply and amplifier section

The Class D amplification circuits ensure that the LA7.16 is energy-efficient for minimal heat dissipation. LA7.16 delivers (12 dB Crest Factor 2 ms, 1kHz, all channels driven, sine burst):

- 16 × 1100 W at 4 Ω
- 16 × 1300 W at 8 Ω
- 16 × 700 W at 16 Ω

LA7.16 is a green amplified controller that relies on a universal Switched Mode Power Supply (SMPS) suitable for mains 100 V AC - 240 V AC ($\pm 10\%$, 50 Hz - 60 Hz). The SMPS features PFC (Power Factor Correction) which maximizes the amplifier efficiency and takes advantage of nearly 100% of the electrical power available with a very high tolerance to unstable mains. This represents a reduction of the electrical power requirements (cable gauge, power conditioning, etc.) for substantial savings.

Speaker outputs

LA7.16 features one SC32 female connector for loudspeaker output.

Speaker protection

The L-DRIVE transducer protection system provides a dual analysis of both signal intensity and voltage in real-time and RMS. Under extreme conditions, when component membranes reach the over-excursion zone or if the coil temperature reaches a critical point, L-DRIVE is activated and acts as a power regulator.

As a result, the amount of power delivered at any channel is adjusted to the dynamic and thermal capacity of each individual transducer.

Monitoring and control

User interface

The front panel is fitted with a 480 × 128 px TFT color touchscreen display and an encoding wheel with push button.



Refer to section [Operation](#) (p.35) for detailed operating instructions.

L-NET remote control network

Remote control of processors and amplified controllers requires setting up a private local area Ethernet network to interconnect up to 253 units (and additional devices such as Ethernet switches / AVB bridges) with a single control computer. This Ethernet network, called L-NET, uses L-COM PROTOCOL, a proprietary communication protocol based on TCP/IPv4.

The integration of the L-NET Ethernet-based network, with its high speed data transfer protocol up to 1 Gb/s, allows up to 253 amplified controllers to be controlled and monitored in real-time from LA Network Manager.

Multiple network topologies such as daisy-chain, star, and hybrid are configurable. The computer running LA Network Manager and the amplified controllers are connected to each other using industry standard CAT5e U/FTP cables (or higher category) fitted with RJ45 connectors.

The LA7.16 connects to the network via the two Ethernet etherCON® I/O sockets located on its rear panel.



Refer to the **LA Network Manager** Help for detailed operating instructions.

Third party management solutions

L-Acoustics is a certified member of the Crestron® partner program, and provides software modules allowing control integration into their automation systems.

L-Acoustics provides a plug-in for control and monitoring of LA2Xi, LA4X, LA7.16, LA7.16i, and LA12X on the QSC Q-SYS platform.

Inspection and preventive maintenance

How to do preventive maintenance

Inspect the product periodically as indicated, and after any corrective maintenance operation.

Structure and cleanness

Before and after each deployment (touring applications), or at least once a month (fixed installations):

- [CHK - External structure](#) (p.19)
- [CHK - Cleanness](#) (p.20)

Functionalities

At least once a year:

- [CHK - Normal start-up sequence](#) (p.20)
- [CHK - Network functionalities and firmware](#) (p.20)

CHK - External structure

The  indicates a visual inspection.

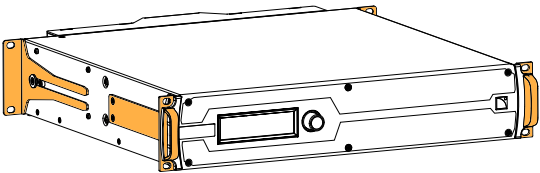

side brackets, front handles, and rear brackets are present and not damaged

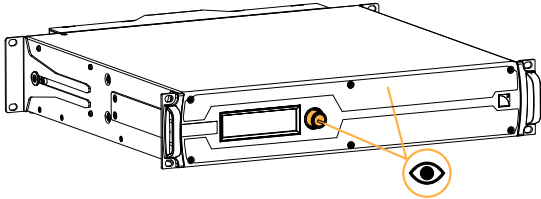

front grill and encoder wheel are present and not damaged
see also [CHK - Cleaness](#) (p.20)

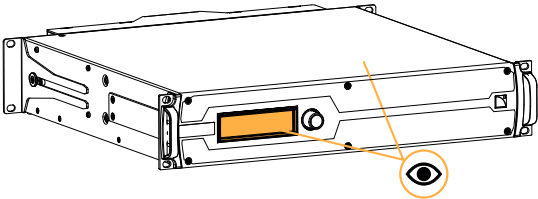

front panel touchscreen display and chassis are not damaged

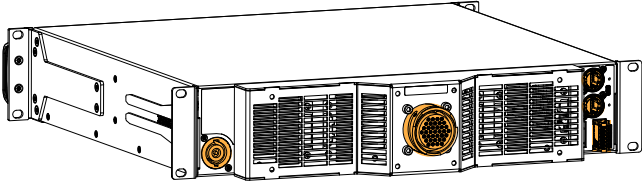

connectors and power cable are not damaged

CHK - Cleanness

Equipment

- air blower

Procedure

Clean the amplified controller through the front grill with an air blower.

CHK - Normal start-up sequence

Procedure

1. Plug the amplified controller to mains.
2. Check that fan noise can be heard for a few seconds during the start-up sequence.

CHK - Network functionalities and firmware

Equipment

- computer with LA Network Manager version 3.5.0 minimum (or 3.4.0 with pilot license)
- appropriate network cable

Procedure

1. Connect the Ethernet port 1 of the amplified controller to an Ethernet port of a computer running LA Network Manager.
Use the appropriate network cable.
2. Run LA Network Manager.
3. Check that the amplified controllers are detected as online Units.
Refer to the **LA Network Manager Help**.
4. Check that all LA7.16 in the system run the same version of the firmware, and that it matches with the version of LA Network Manager in use.
Refer to the **LA NWM and Firmware Compatibility Issues** technical bulletin.
5. If convenient, update LA Network Manager and the firmware to the latest versions.
 If using a third-party control system such as Crestron or QSC Q-SYS, check that updating the firmware does not break compatibility.

Installation

Mounting

The LA7.16 is two rack units high (2U) and can be mounted in an EIA-standard 19" rack using the four points on the front panel. Use the fixing material provided by the rack manufacturer to mount the controller to the rack front rails.

LA7.16 dimensions

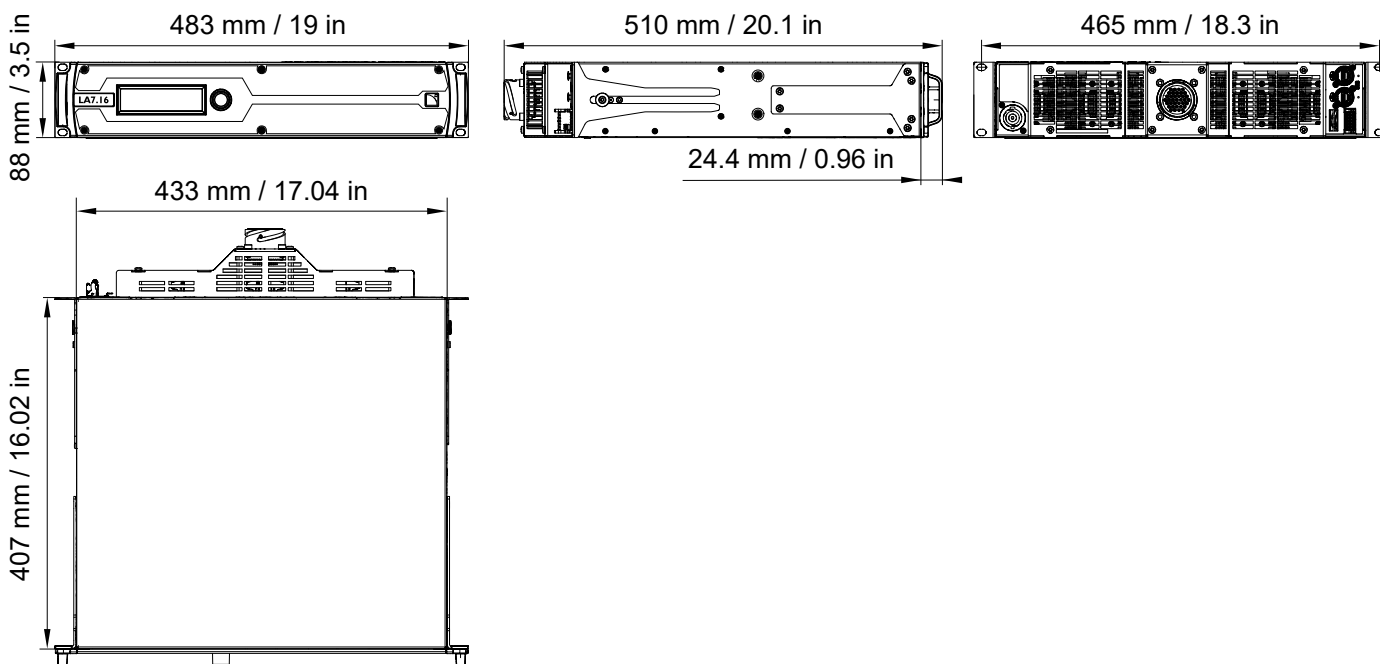

LA7.16 with rear rack support brackets

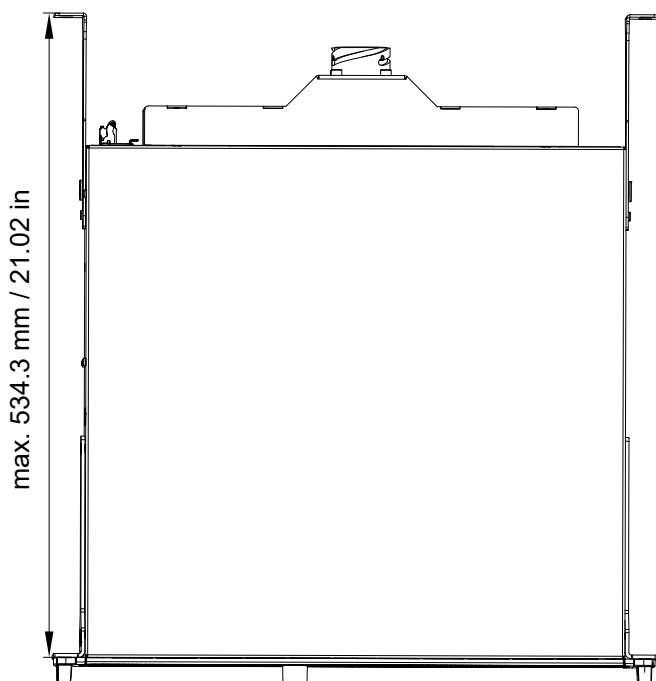

Risk of damaging the amplified controller

The amplified controller should be rear supported in addition to the front panel mounting.

Use the rear brackets provided with the amplified controller.

Any mechanical damage to the amplified controller used without rear support is not covered by warranty.

Ventilation

To maintain moderate operating temperatures, the LA7.16 is equipped with DSP-controlled fans and grills providing front to rear airflow.

Ventilation instructions

Install the controller in an open area so that the front and rear panels are located at a minimum distance of 30 cm / 12 in from any external object or structure.

Ensure the front grill is clean and dirt free.

Do not block the front and rear ventilation grills.

Ventilation when rack-mounted

Do not block the ventilation grills with front or back panels or doors. If not possible, use a forced-ventilation system.

When stacking more than one controller in a rack, mount them directly on top of each other or close any open space in the rack with blank panels.

General Purpose I/O (GPIO)

The amplified controller's rear side features a 12-point terminal block General Purpose I/O (GPIO).

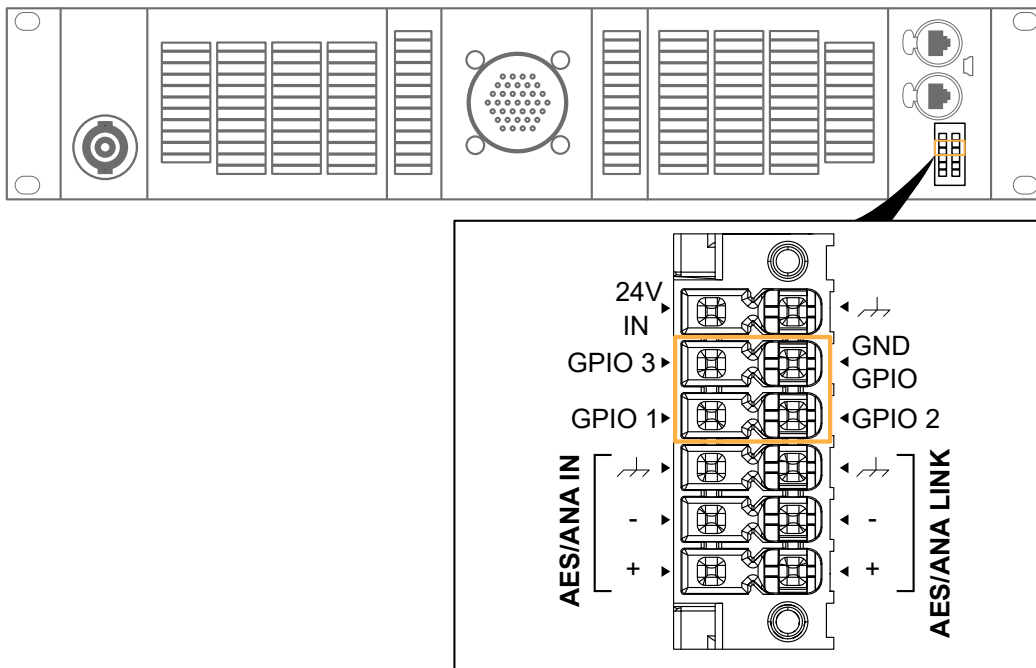

Pin	Description		Pin
GPIO 3	General Purpose I/O 3	GPIO ground	GND GPIO
GPIO 1	General Purpose I/O 1	General Purpose I/O 2	GPIO 2

GPIO can be configured using LA Network Manager. For more information, refer to the **GPIO on L-Acoustics products** technical bulletin.

Connecting to AC mains

Electrical specifications

AC mains specifications

-  **Verify the electrical conformity and compatibility of the mains supply.**
 Only connect the product to an AC power outlet rated 100-240 V, 50-60 Hz, with the following current values:
 100-120 V: 30 A
 220-240 V: 16 A
 WARNING: The product is of Class 1 construction and shall be connected to a mains socket outlet with a Protective Earth connection.

Three-phase circuit

-  **When the product is used in a three-phase circuit, verify the electrical conformity and compatibility of the three-phase circuit.**
 Verify that the three phases work, and balance the loads between the three phases.
 Verify that the neutral and earth work.
 Never try to emulate a 230 V circuit connecting an apparatus to two live wires of a 120 V three-phase circuit.
 Never try to emulate a 200 V circuit connecting an apparatus to two live wires of a 100 V three-phase circuit.

Circuit breaker

-  **The power supply feeding LA7.16 must be equipped with circuit breakers meeting the following requirements:**
 The circuit breaker must operate on each phase separately (no mechanical link between phases).
 Use these references, or equipment with equivalent characteristics:
 100-120 V: 30 A, Schneider Electric Square D 30A QO (in North America), or Mitsubishi CP30-BA-M (in Japan).
 220-240 V: 16 A, Type C.
 Circuit breakers of different characteristics could trip in case of short-term, high current draw, because they do not match LA7.16 Fuse Protect algorithms.

Planning the power of the electrical generator

-  **Electrical generator**
 You must power on the generator before powering on the product.

LA7.16 draws 16 A from 230 V.

A typical generator has a power factor of 0.8 and should operate at 70% load for good efficiency.

The kVA provision for one LA7.16 should therefore be:

$$(16 \text{ A} \times 230 \text{ V}) / (0.8 \times 70\%) = 6.5 \text{ kVA}$$

This calculation is an example using typical values. It can be adapted using the table in section [Power consumption](#) (p.25).

Power cord

The removable power cord is fitted at one end with a 32 A powerCON connector.

The other end and the wires color code depends on the cord type, as follows:

type	plug	live	neutral	ground
CE	CEE 7/7, 16 A / 250 V, grounded	brown	blue	green/yellow
CN	GB1002 GB2099, 16 A			
US	NEMA L5-30P, 30 A / 125 V, grounded	black	white	green
INT	bare ends (local power plug to be fitted)	black	white	green/yellow



Strictly apply the specific safety regulations of the country of use.

Do not defeat the ground connection of the supplied power cord using an adaptor or any other method.

Verify that the plug conforms to the specific voltage and current rating given in section [Electrical specifications](#) (p.23).

Plugging the amplified controller

How to plug the amplified controller to the AC mains.

Procedure

- First, connect the powerCON to the amplified controller mains panel.

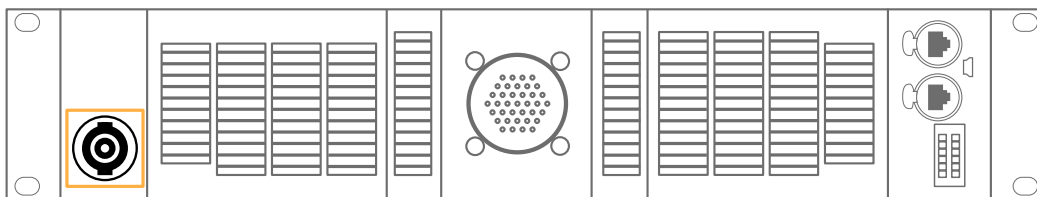

- Then, connect the power plug to the mains socket.
Following this order improves the powerCON longevity.

Power consumption

The LA7.16 power requirements depend on the load impedance and the signal level.

Mains input power and current draw (all channels driven)

Maximum output power (CEA-2006 / 490A 20 ms, $\leq 1\%$ THD, 1 kHz, all channels driven, sine burst)	16 x 580 W at 16 Ω	16 x 920 W at 8 Ω	16 x 1000 W at 4 Ω
1/3 output power (-5 dB)	16.9 A / 3800 W	18.6 A / 4200 W*	19.2 A / 4300 W*
1/8 output power (-9 dB)	6.7 A / 1500 W	11.2 A / 2500 W	13 A / 2900 W

! * 1/3 output power measurements given for 11 channels (8 Ω) and 10 channels (4 Ω) loaded using the same signal simultaneously.

For more channels using the same signal simultaneously, the amplified controller will reduce output power below 1/3 output power.

Current values given for mains rated at 230 V. Multiply by:

- 2.3 for 100 V
- 1.92 for 120 V
- 1.15 for 200 V

i Output power references

A third (1/3) of the maximum output power corresponds to the worst case scenario of a program source using highly compressed music or pink noise with amplified controller driven to clip level.

An eighth (1/8) of the maximum output power corresponds to a loud music program with a small dynamic range and 9 dB of headroom (IEC standard power rating).

Mains input power and current draw in Idle and Standby modes

	230 V	120 V	100 V
Idle	1.0 A / 140 W	1.3 A / 140 W	1.4 A / 140 W
Standby	0.8 A / 19 W	0.5 A / 19 W	0.5 A / 19 W

Heat power calculation

If a 8Ω load is connected to each output channel of the LA7.16, each channel delivers up to 920 W.

With a standard use at one eighth (1/8) of full power (9 dB headroom), the power delivered per channel is:

$$920 \text{ W} / 8 = 115 \text{ W}$$

Therefore, a total power of:

$$16 \times 115 \text{ W} = 1840 \text{ W}$$

According to the table in section [Power consumption](#) (p.25), the LA7.16 power consumption is 2500 W. The heat power produced is then (difference between power consumption and output power):

$$2500 \text{ W} - 1840 \text{ W} = 660 \text{ W}$$

24 V DC Input

The amplified controller's rear side features a 12-point terminal block for external powering of the DSP in case of mains failure.

In case of power failure, 24 V DC input (if used) allows for a faster recovery of the amplified controller and continued reporting and monitoring of the network and DSP.

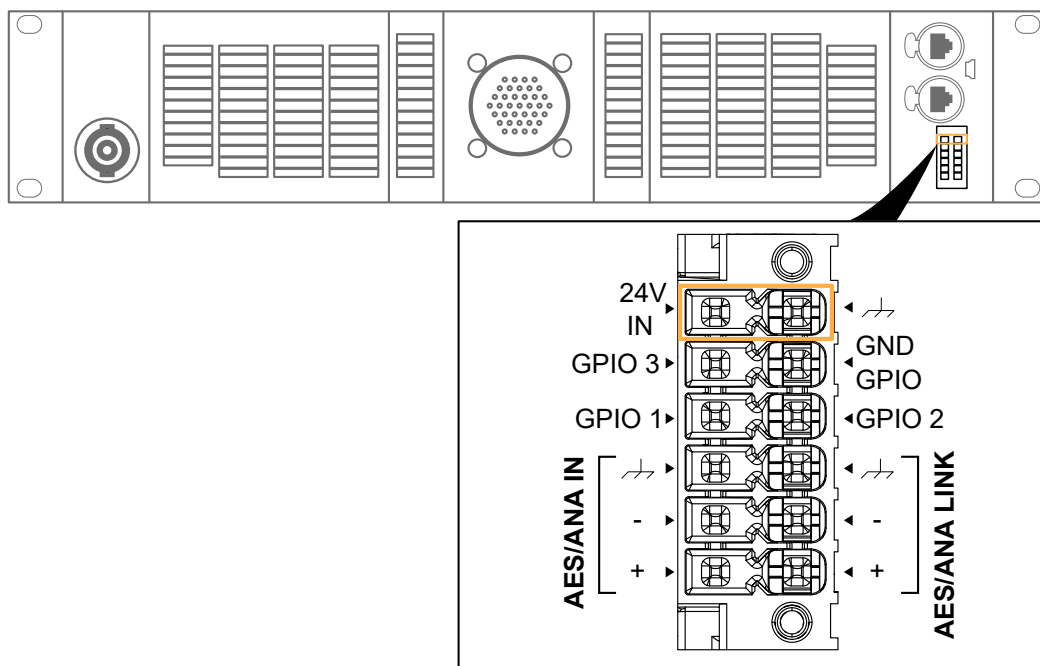

The external power supply should be rated 24 V DC ($\pm 15\%$) 17 W maximum.



LS10 24 V DC output is not powerful enough to supply LA7.16 DSP.

The amplified controller must be connected to the mains for firmware updates. Firmware updates cannot be performed when the amplified controller is solely powered by the 24 V DC input.

Audio and network cabling

Connection panels

The amplified controller's rear side features connectors for audio and network cabling:

1. For connection to the loudspeakers.
2. For connection of the analog or digital (AES/EBU) audio sources, and for linking the signals to another amplified controller.
3. For connection to an AVB network, and to be remotely controlled by LA Network Manager.

LA7.16 audio and network connection panels

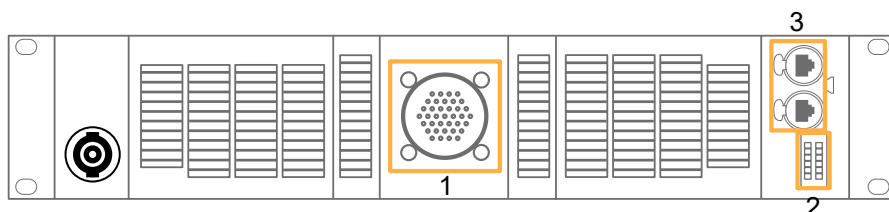

Speaker panel

The SC32 female connector on the rear panel is for loudspeaker connection. It is wired as follows:

Pin A	Out 1 +	Pin T	Out 9 +
Pin B	Out 1 -	Pin U	Out 9 -
Pin C	Out 2 +	Pin V	Out 10 +
Pin D	Out 2 -	Pin W	Out 10 -
Pin E	Out 3 +	Pin X	Out 11 +
Pin F	Out 3 -	Pin Z	Out 11 -
Pin G	Out 4 +	Pin a	Out 12 +
Pin H	Out 4 -	Pin b	Out 12 -
Pin J	Out 5 +	Pin c	Out 13 +
Pin K	Out 5 -	Pin d	Out 13 -
Pin L	Out 6 +	Pin e	Out 14 +
Pin M	Out 6 -	Pin f	Out 14 -
Pin N	Out 7 +	Pin g	Out 15 +
Pin P	Out 7 -	Pin h	Out 15 -
Pin R	Out 8 +	Pin j	Out 16 +
Pin S	Out 8 -	Pin k	Out 16 -
		Pin m/n/p/r/s	not used

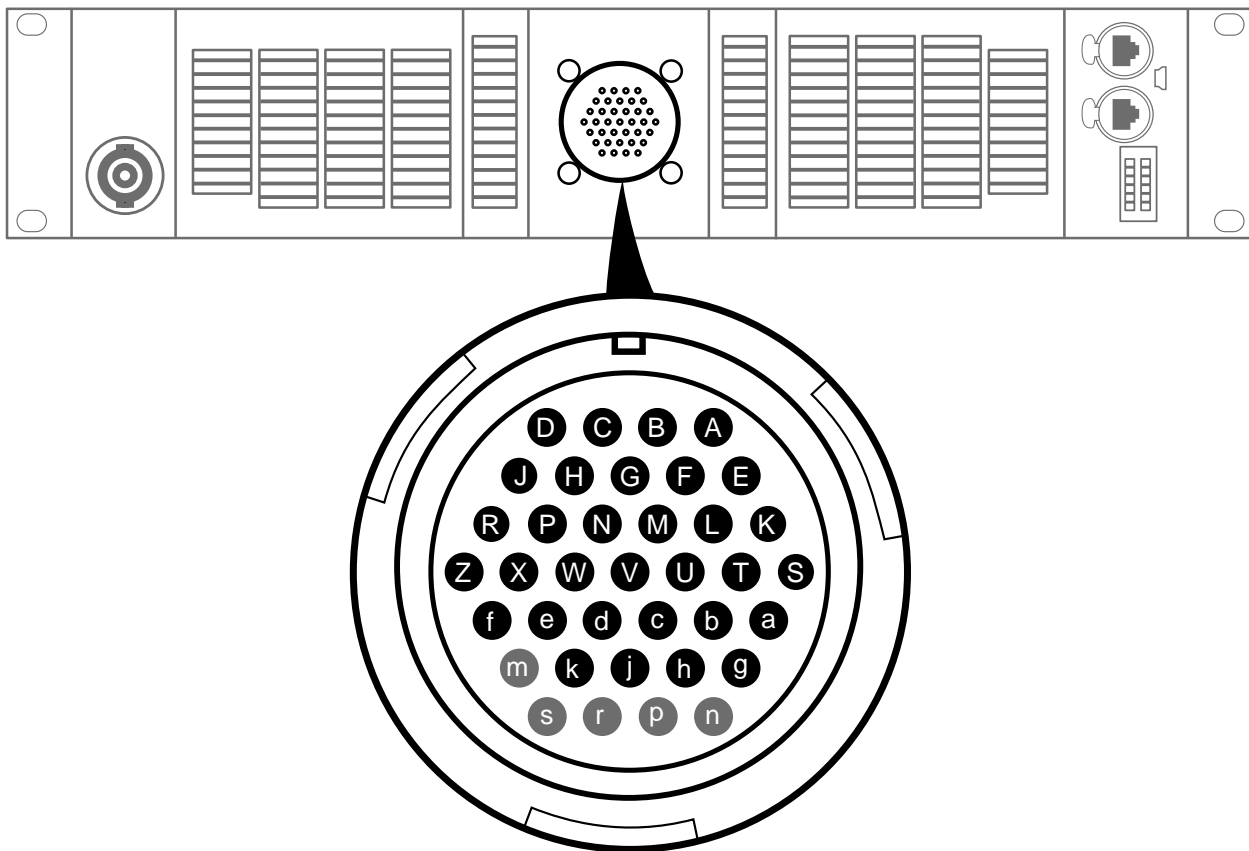

Analog/Digital output connectors

Use the male 12-point terminal block for digital (AES/EBU) and analog signal cabling.

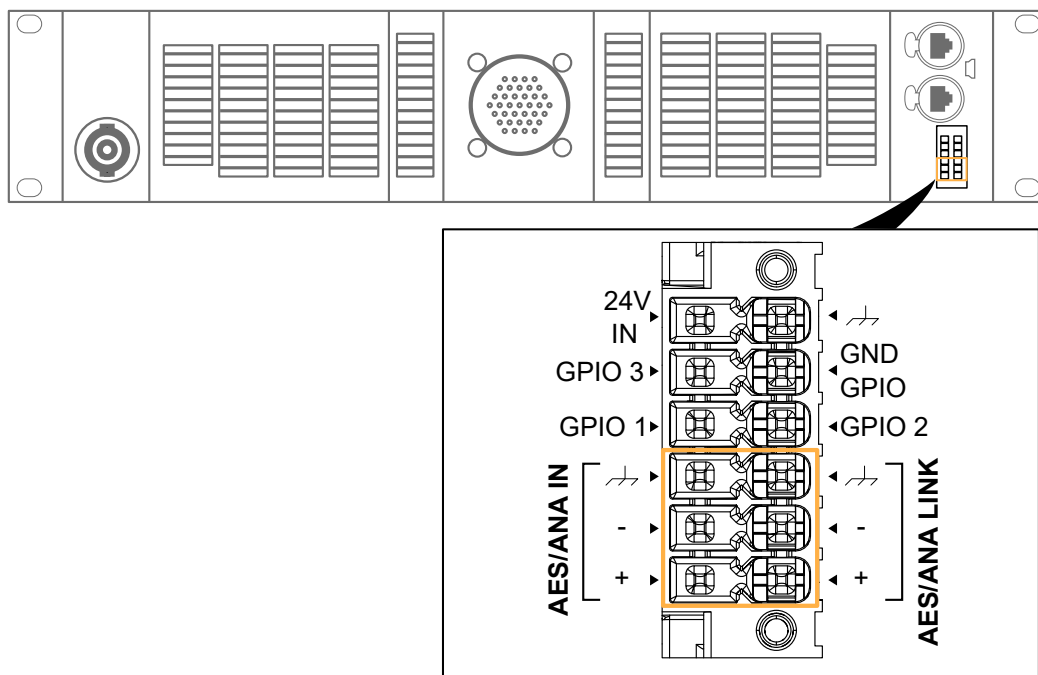

Analog inputs

AES/ANA IN can receive one analog signal (when setting the analog input mode). The headroom of the input circuits is high enough to accept the maximum output level from almost any line-level signal source (up to 22 dBu).

The input signals can be transmitted to daisy-chained amplified controllers using AES/ANA LINK.

AES/EBU inputs

Supported digital input format

Standards	AES/EBU (AES3)
Sampling frequency (Fs)	44.1, 48, 88.2, 96, 176.4, or 192 kHz
Word length	16, 18, 20, or 24 bits
Synchronization	signal resampled to internal clock at 96 kHz

AES/ANA IN can receive up to two (one stereo pair) digital signals (when setting the AES/EBU input mode).

The AES/ANA LINK connector is electronically buffered to allow daisy-chaining any number of amplified controllers. It also features a failsafe relay to ensure wiring continuity in case of amplified controller shutdown.

Ethernet connectors

Use the two etherCON connectors for the remote control of LA7.16 over the L-NET network using LA Network Manager. The etherCON connectors are AVB-capable.

In normal network mode, the two etherCON connectors are part of an internal AVB switch, and allow for daisy-chaining of additional devices.

In redundancy mode, the two etherCON connectors are independent: the LINK/ACT 1 connector is used for the primary network, and the LINK/ACT 2 connector is used for the secondary network.

Analog audio

i Balanced cables

Symmetrical (balanced) shielded cables are highly recommended as balanced signals are less sensitive to AC hum and radio interference.

Unbalanced lines may add noise especially over long cable runs.

In a daisy-chain layout, the AES/ANA LINK feeds the input signal to the next amplified controller in the signal chain.

daisy-chaining analog audio

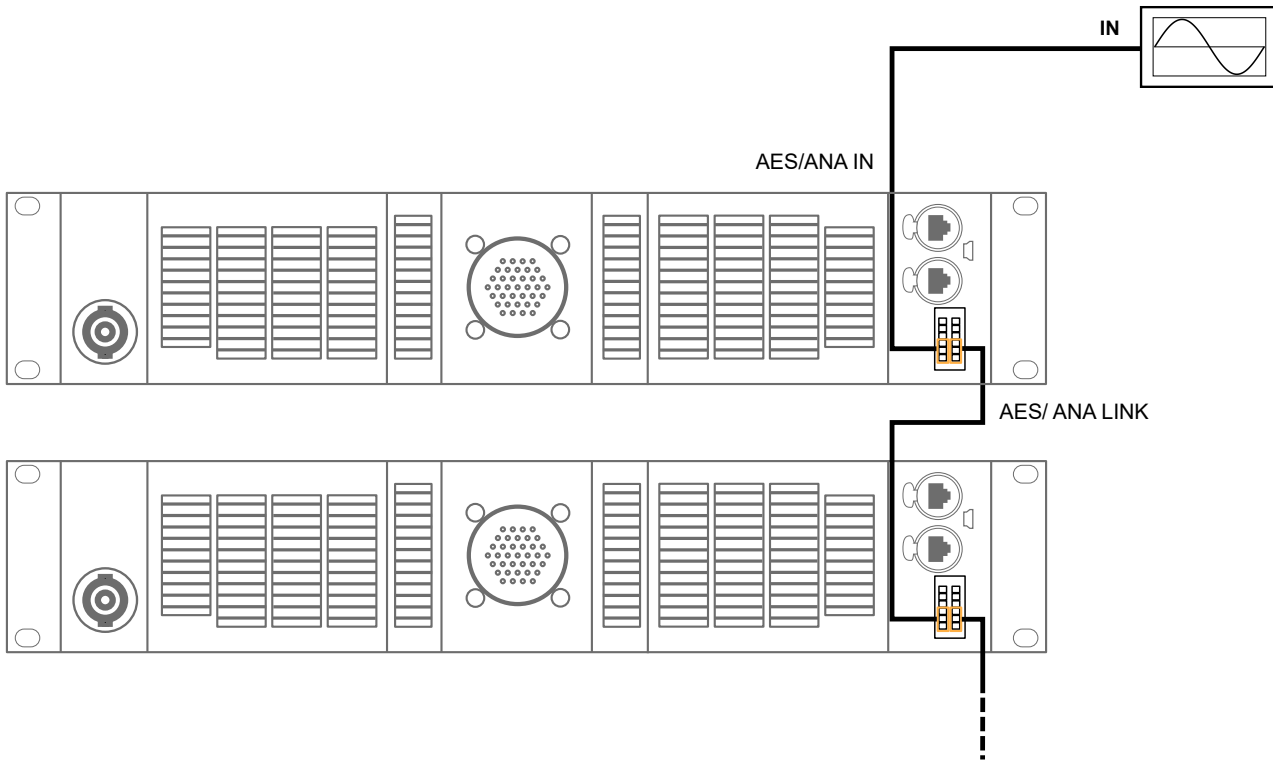

Digital audio

In a daisy-chain layout, the AES/ANA LINK feeds the input signal to the next amplified controller in the signal chain.

daisy-chaining digital audio

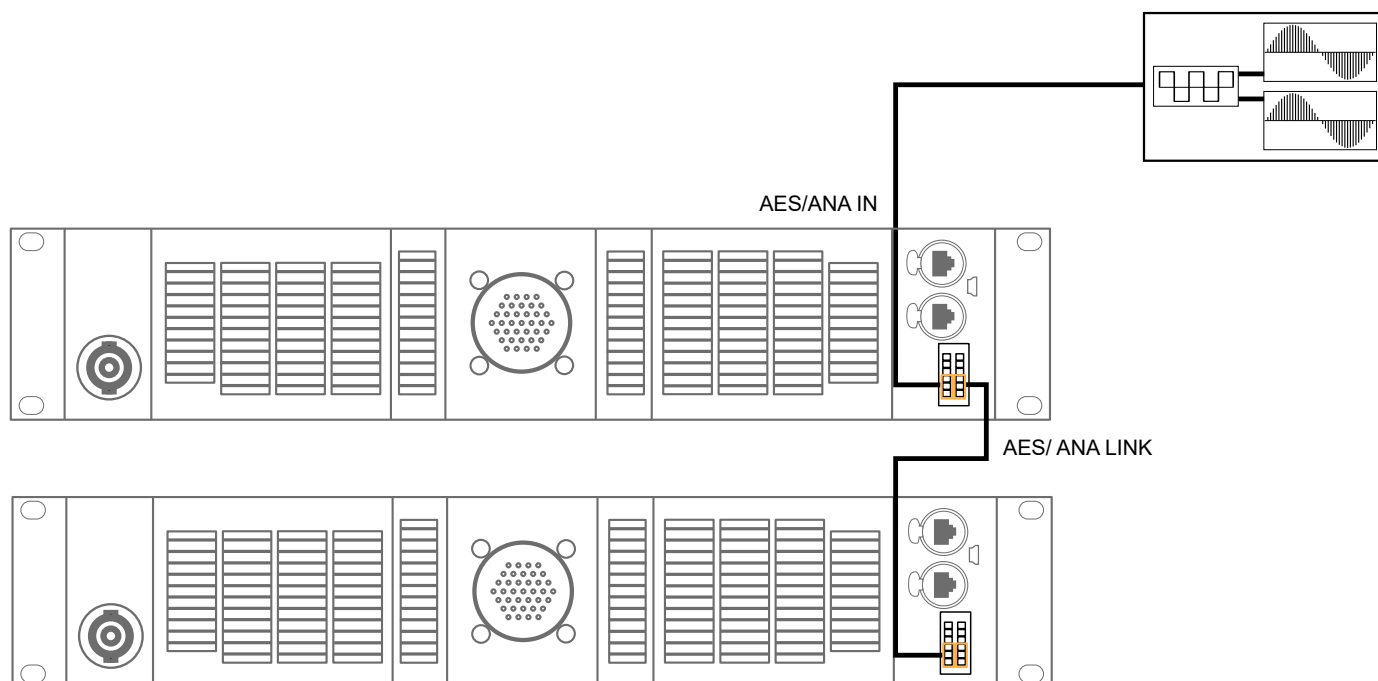

Cables for AES/EBU digital audio

AES3 specifies that the nominal characteristic impedance of cables used for AES/EBU digital audio transmission shall be $110 \Omega \pm 20\%$, and closer tolerances allow for increased transmission reliability over long lengths or higher sampling rates.



Therefore, it is highly recommended to use high-quality AES/EBU rated cables only, although certain cables designed for balanced analog audio prove to be acceptable at 48 kHz sampling rate over very short distances.

It is recommended to use single lengths of cable between AES/EBU outputs and inputs. Using several shorter cables joined together reduces performance. If it is not possible to use single lengths, it is required to use the same model of cable between two AES/EBU interfaces.

In case an amplified controller shuts down, the failsafe relay makes a passive connection between the AES/EBU IN port and the LINK port to maintain continuity. However the signals are no longer refreshed for the next amplified controller, so that the input cable and the link cable must be considered as a unique input cable with regard to the maximum supported length.

In case of transmission losses, try to reduce the sampling frequency of the digital audio source. Moreover, as a general rule, avoid using sources rated beyond 96 kHz, as the maximum possible cable length is reduced, while the additional information is discarded by the SRC to 96 kHz.

L-NET/AVB

-  **Do not create loops in the network setup.**
-  **In daisy-chain networks, always place LA4X with hardware version* ID1, ID2 or ID3, LA4, and LA8 after any other type of amplified controller.**

These amplified controllers are equipped with former generation 100 Mb/s Ethernet ports that cannot communicate with Ethernet ports of different capabilities, creating detection issues in LA Network Manager.

*The LA4X hardware version is visible in the MONITORING & INFO menu (HARDWARE INFO section).

Use the two etherCON connectors on the rear panel to connect LA7.16 both to L-NET and to an AVB network. Real-time audio traffic and control traffic are automatically managed by AVB on the same network.

LA7.16 supports AVB Milan in normal mode and in redundant mode. In Redundant mode, LA7.16 must be connected in star topology, port 1 being used for the primary network, port 2 being used for the secondary network. In normal mode, daisy-chain, star, or hybrid topologies are supported.

Refer to the **LA Network Manager** Help for network setup.

Remote control of processors and amplified controllers requires setting up a private local area Ethernet network to interconnect up to 253 units (and additional devices such as Ethernet switches / AVB bridges) with a single control computer. This Ethernet network, called L-NET, uses L-COM PROTOCOL, a proprietary communication protocol based on TCP/IPv4.

An IP address is a unique identifier for a network device on a given IP network. In IPv4 networking, it is made of 4 bytes (32 bits). An IP address is composed of a subnet address and a host address. The host address serves as a unique device identifier on the subnet. The subnet mask determines how many bits define the subnet address, and how many define the host address.

By convention, the first possible number of the host address is reserved to designate the subnet, and the last number is reserved to communicate with all devices of the subnet (IP broadcast address).

The factory default IP settings of all L-Acoustics devices are:

- IP address: 192.168.1.100
- Subnet address: 192.168.1.0/24
- IP broadcast address: 192.168.1.255
- Subnet mask: 255.255.255.0

With these settings, the first three bytes of the IP address (192.168.1) define the subnet address, and the last byte is the host address (100).

In general, it is recommended to:

- Use the default subnet address and subnet mask.
- Edit the device host address to provide a unique identifier to each unit: use consecutive IP addresses starting from 192.168.1.**1** up to 192.168.1.**253**.
- Set the control computer to 192.168.1.**254**.

However, it is possible to configure other IP settings when required by network administration. Subnet mask may be defined from 255.0.0.0 to 255.255.255.0, and the IP and gateway addresses must both belong to one of the following IP ranges (standards for Private Local Area Networks):

- 10.0.0.1 to 10.255.255.254
- 100.64.0.1 to 100.127.255.254
- 172.16.0.1 to 172.31.255.254
- 169.254.0.1 to 169.254.255.254 (not recommended)
- 192.168.0.1 to 192.168.255.254

-  **LA Network Manager and its host computer must be using the same subnet and Subnet mask as the units.**

In AVB redundant mode, the host address is always made identical for both the Primary and the Secondary network. The subnet address of the Secondary network is that of the Primary + 1. For example, with default settings:

- Primary port: 192.168.**1**.100
- Secondary port: 192.168.**2**.100

The subnet mask setting always applies to both networks. When using smaller subnet masks, the host address is also made identical. For example:

- Primary port: 172.**16**.1.100
- Secondary port: 172.**17**.1.100

The Gateway address is only available for the Primary network.

For subnet settings, refer to the **LA Network Manager** Help.

Speaker

Use the SC32 female connector and SC32 cables to connect an enclosure to the amplified controller.

For cabling schemes, refer to the enclosure owner's manual or the **Amplification reference** technical bulletin.

For the enclosure drive capacity per amplified controller, refer to the **Amplification reference** technical bulletin or the **Preset guide**.



Using multicore loudspeaker cables

Never connect more than one amplified controller on a single multicore loudspeaker cable.

Connecting several amplified controllers may cause audible interferences on the loudspeaker enclosures when the amplified controllers are in idle mode, even when muted.

Connector references

usage	number	type	reference	max. cable gauge
GPIO	1	female 12-point terminal block (pitch 3.5 mm / 0.137")	Phoenix DFMC 1,5/6-ST-3,5 – 1790522	1.5 mm ²
24 V DC input				
AES/ANA input				
AES/ANA link				

PHOENIX CONTACT is a trademark of PHOENIX CONTACT GmbH & Co. KG.

Operation

Powering on/off

LA7.16 turns on immediately when plugged, and turns off immediately when unplugged (no on/off switch), refer to [Plugging the amplified controller](#) (p.25).

If power is lost, the amplified controller shuts down, but all parameters are restored when the amplified controller is powered again.

To set the amplified controller to standby or back to operating mode:

- change the unit status in LA Network Manager (refer to the **Help**), or
- use the front panel menu. Refer to [Standby](#) (p.67).

Parameters accessible only from LA Network Manager

Most parameters are accessible both from the LA7.16 front panel and from LA Network Manager.

The following can be done only in LA Network Manager:

- Reboot.
- Connect input streams. Once connected, the streams can be associated to DSP inputs in [Input source selection](#) (p.46).
- Configure the GPIO.
- Customize the enclosure layout: select a different enclosure set or preset, or change the N//.
- View or edit channel set assignments to groups.

Using the interface

LA7.16 is equipped with an encoding wheel with push button and a color touchscreen display.

Navigating between pages:

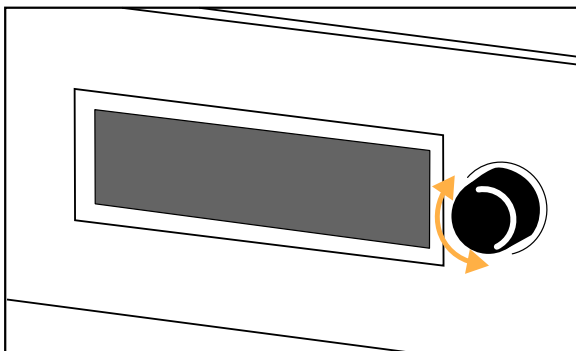
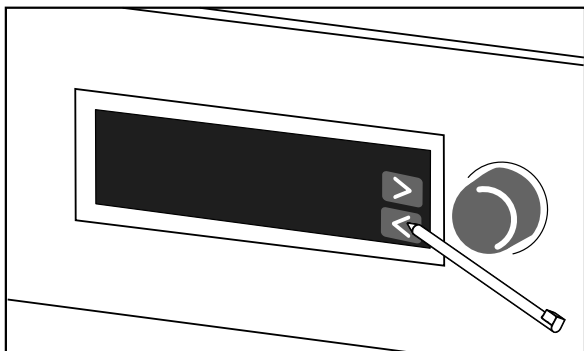

Changing selection or setting:

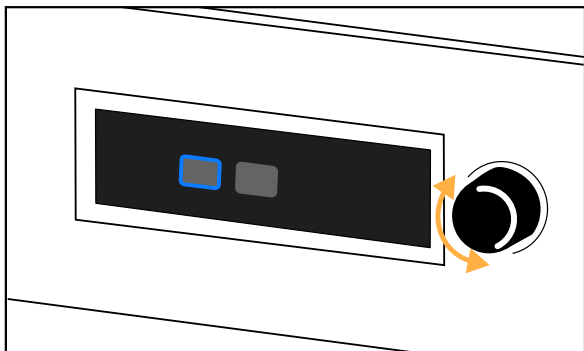

Validating selections:

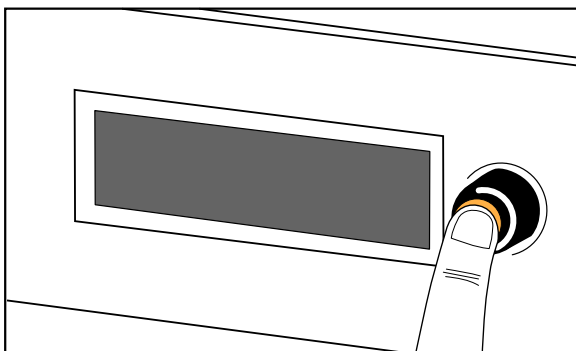
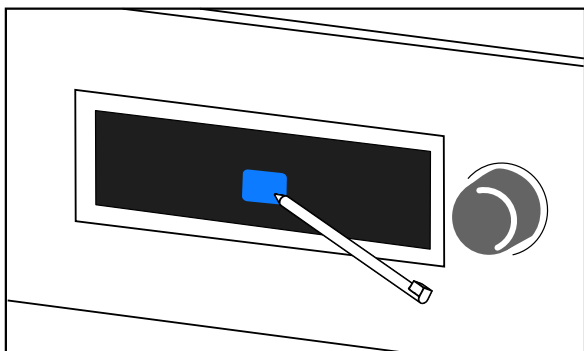

Returning to the previous screen:

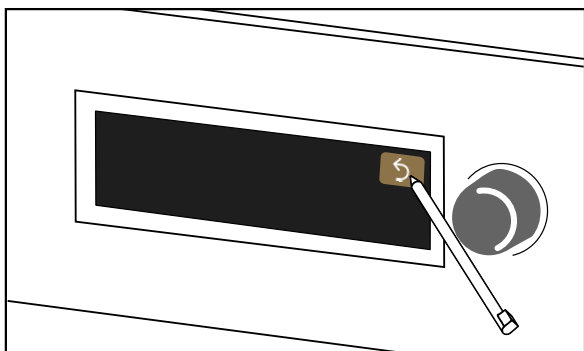

Editing gain or delay

Values with decimal points (gain or delay) can be edited by pressing the button on the screen and turning the wheel. When pressing and turning the encoder wheel, the increment or decrement is higher.

The values can be positive or negative.

To select whether button selections are additive (multiple selections), or exclusive (one item at a time), refer to [Preferences](#) (p.63).

Gain

- turn the encoder wheel to change the value by 0.1 dB
- press and turn the encoder wheel to change the value by 1.0 dB

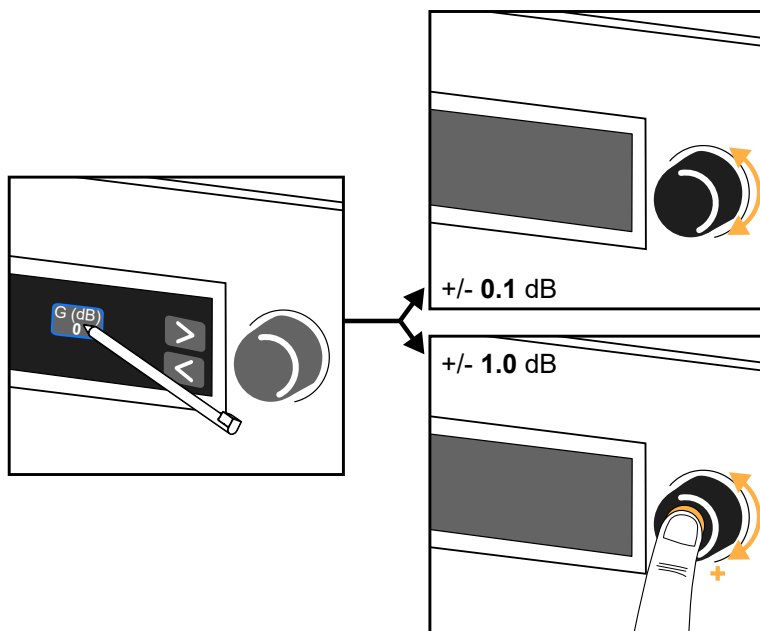

Delay

- turn the encoder wheel to change the value by 0.01 ms/meters/feet, or by 1 sample
- press and turn the encoder wheel to change the value by 0.1 ms/meters/feet, or by 10 samples

Press and maintain the delay button to display a numeric keypad.



The delay unit is ms by default and can be changed in [Preferences](#) (p.63).

Using the main screen

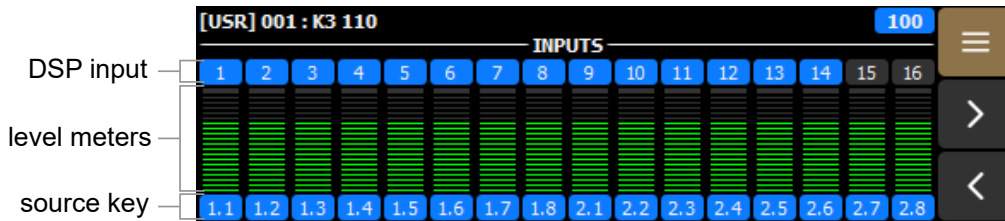
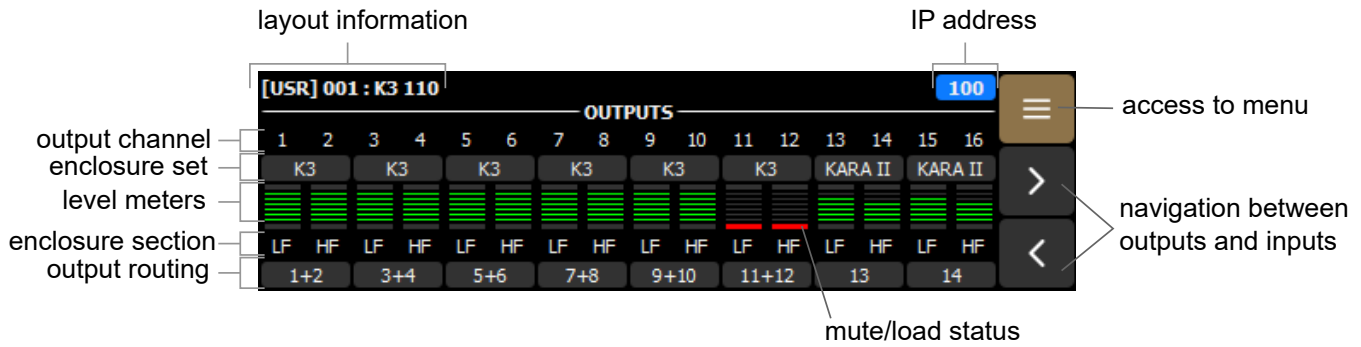

Layout name, type, and index

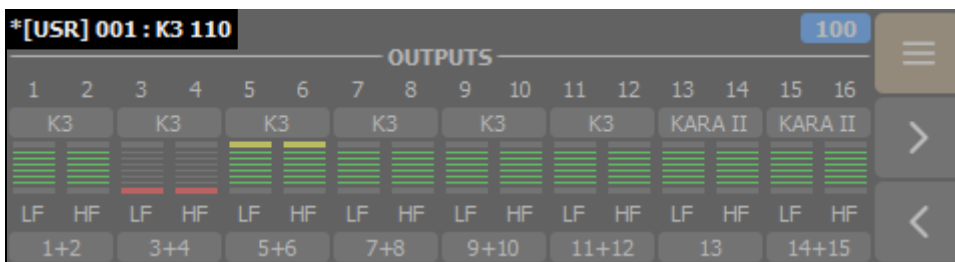

- * (star sign): indicates unsaved modification
- [LIB]: factory layout, [USR]: user layout, [CFG]: configuration* or none for unsaved layout
- memory space number: from 001 to 010 for user layouts, from 001 to 075 for factory layouts, or 000 for unsaved layout
- layout name

* For fixed installation. Refer to **AV Control Systems Overview** technical bulletin.

IP address

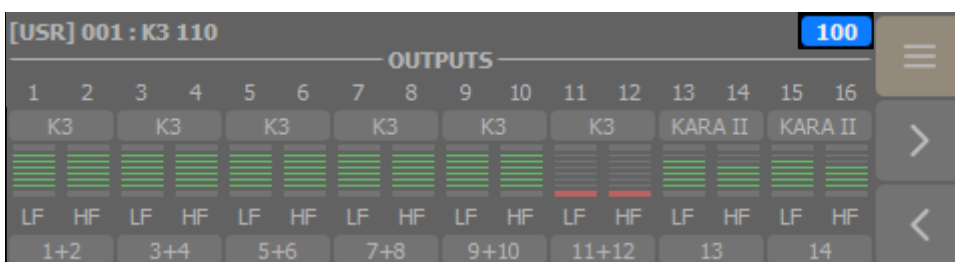

This number corresponds to the last number of the LA7.16 IP address (from 1 to 254). Refer to [IP settings](#) (p.65).

- 100** LA7.16 is not connected to LA Network Manager, or to any L-COM based remote controller.
- 100** LA7.16 is connected to an L-COM based remote controller, but not to LA Network Manager.
- 100** LA7.16 is connected to LA Network Manager, and may be also connected to another L-COM based remote controller.

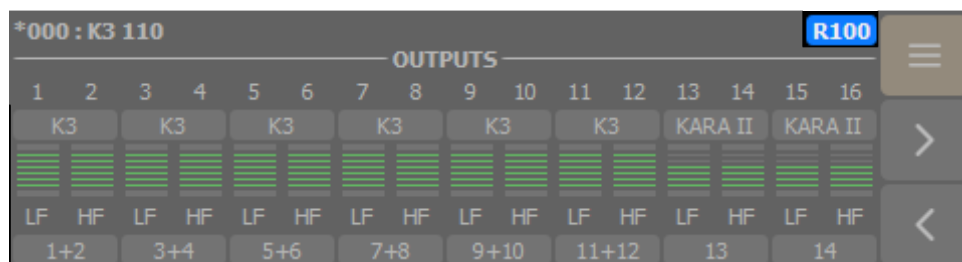

R is displayed in front of the IP address when redundancy mode is enabled. Refer to [Network switch](#) (p.62).

A warning icon can be displayed in front of the IP address. Refer to [Event history](#) (p.61).

Outputs view

The 16 output channels are represented in the Outputs view, with enclosure set name at the top of the level meters and enclosure section and output routing at the bottom.

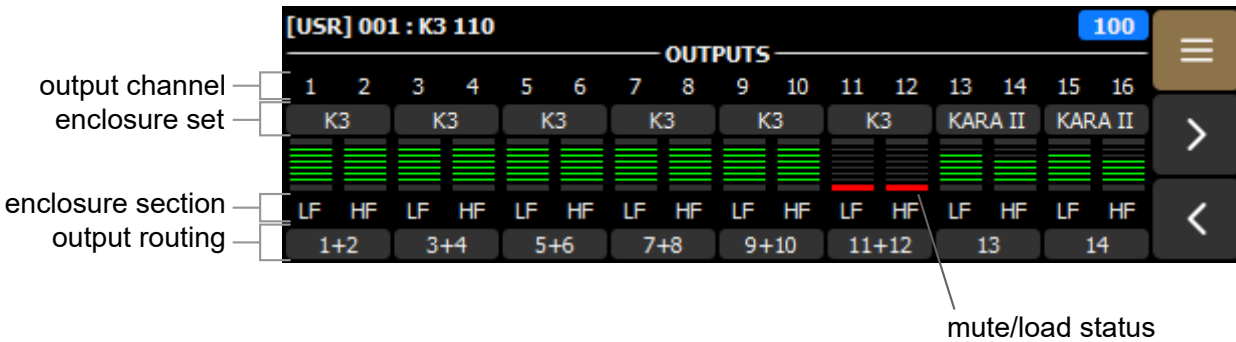

Latency mode

An output channel with a light gray background indicates a low latency mode. The latency mode depends on the preset selected in LA Network Manager. The preset name can be viewed in [Layout details \(stacked view\)](#) (p.44).

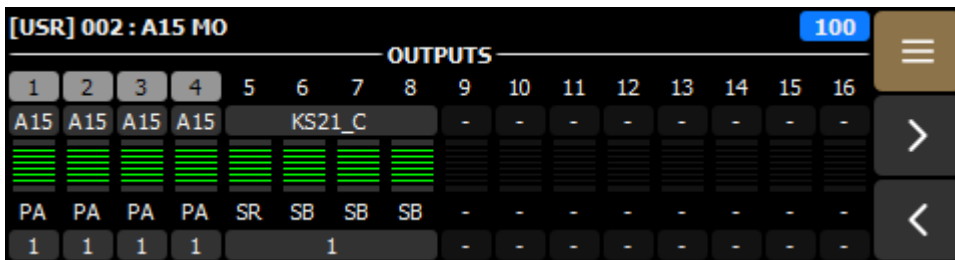

Empty channels

Empty output channels have a "-" in place of the enclosure set name, the enclosure section, and the output routing.

Level meters

The output level meters are displayed starting with -60 dBFS. They have a limit/clip indicator at the top.

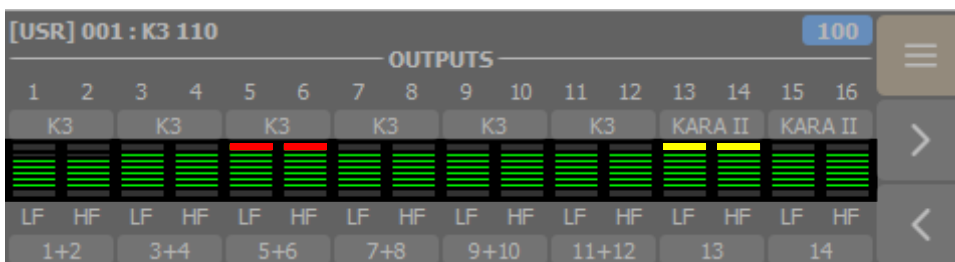

Clip/limit indicator color code

- red The output voltage reaches the maximum level (signal clip).
- yellow The L-DRIVE limiter is activated with gain reduction of at least 3 dB.

Enclosure section

The two letters at the bottom of the level meter indicate the type of transducer section or the type of enclosure (for one-channel enclosures) that is connected to the output channel:

- LF: low frequency transducer section, part of a 2 or 3-way loudspeaker enclosure
- LC: low cardioid transducer section
- MF: mid frequency transducer section, part of a 3-way loudspeaker enclosure
- HF: high frequency transducer section, part of a 2 or 3-way loudspeaker enclosure
- PA: passive loudspeaker enclosure
- SB: subwoofer enclosure with the front face towards the audience

- SR: subwoofer enclosure with the front face in the opposite direction from the audience (in a cardioid configuration)

Mute/load status

The indicator at the bottom of the level meters indicates the mute or load status:

- red The channel is muted. To mute/unmute outputs, refer to [Enclosure section icons](#) (p.43).
- green A load is detected and the output module delivers a minimum of 0.2 A.

Output routing

The output routing is indicated at the bottom of the level meters for each enclosure set. When multiple DSP inputs are routed to an enclosure set, they are joined by a plus (+) sign. If not all DSP input numbers can be displayed, the list ends with a plus (+) sign. To change the routing, refer to [Output routing](#) (p.51).

Inputs view

The 16 DSP inputs are represented in the Inputs view, with DSP input number at the top of the level meters and source key at the bottom.

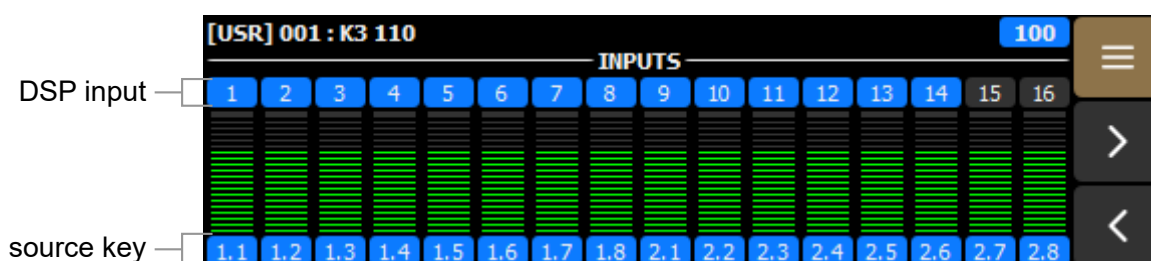

DSP inputs

DSP inputs have a blue background when they are routed to an output and dark gray background when they are not.

Level meters

The input level meters have a clip indicator at the top. It is red when the signal reaches -0.1 dBFS.

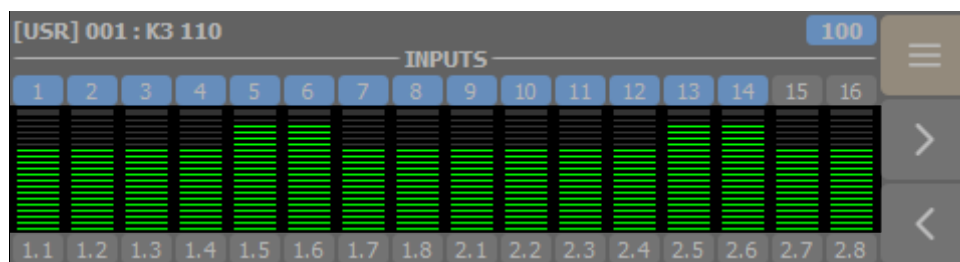

Source key

The source key indicates the source that is mapped to this DSP input. The source key depends on the input type:

- x.y: AVB mode (stream number and channel number)
- A: Analog mode
- L or R: AES/EBU mode, left or right channel
- -: not connected

Source key color code

1.1 AVB source is active and a fallback is defined

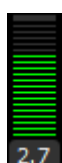

AVB source is active and no fallback is defined



AVB source is in error and no fallback is defined



AVB source is in error and a fallback is defined and currently active



AVB source is ready to be re-enabled* and a fallback is defined and currently active



AUX Analog source is routed



AUX AES/EBU source is routed



No source is defined for this DSP input

*To clear the fallback, refer to [Fallback](#) (p.48).

Using the input/output pages

Access the input/output pages through their level meters.

Outputs

The 16 output channels are grouped by 8 in the output pages. Press the arrows to navigate between 1-8 and 9-16.

The output pages have stacked views to access additional information about the enclosure layout. Press 1/2 and 2/2 to navigate between the stacked views.

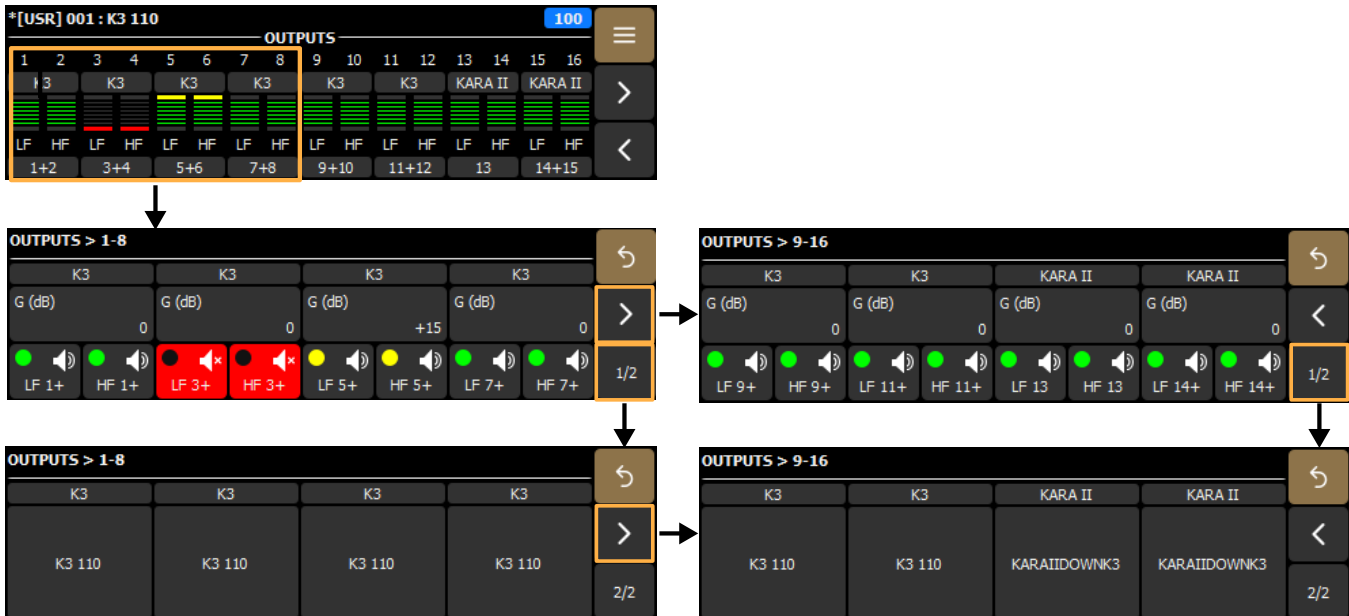

Gain

The gain can be changed for each enclosure set. Refer to [Editing gain or delay](#) (p.37).

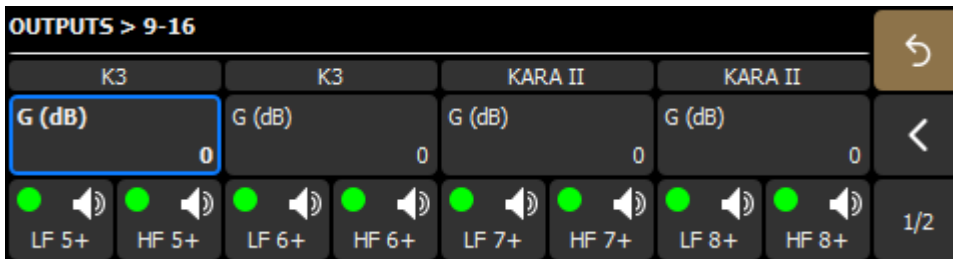

Alternatively, the gain can be modified in the layout parameters. Refer to [Gain \(dB\)](#) (p.51).

Enclosure section icons

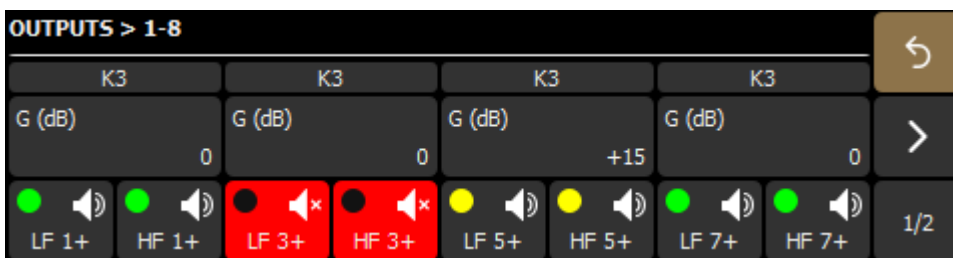

Output pages have individual buttons for each enclosure section that display:

- the limit/clip status
- the enclosure section name
- the first routed DSP input number, followed by a + if there are multiple inputs*
- the mute status



output is not muted



output is muted



output is limiting



output is clipping

*The output routing can be viewed and changed in [Output routing](#) (p.51).

Press the button to mute the output. To mute multiple channels at once, slide the finger over all the buttons.

Layout details (stacked view)

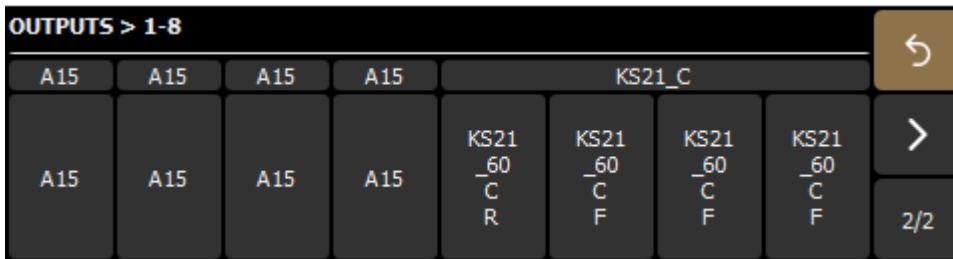

Press 1/2 to display the presets selected on each output channel, grouped by enclosure set.

Use LA Network Manager to change the presets or the enclosure layout.

Inputs

The inputs page provides an overview of the status of each DSP input and access to the source parameters.



DSP input icons

Each DSP input is represented by an icon with a signal LED and input source and fallback information.

signal LED

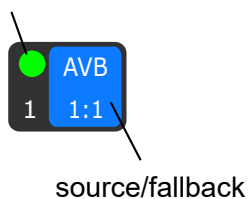

Signal LED



There is a signal of at least -60 dBFS.



No signal is detected.

Source and fallback information

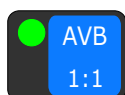

AVB source is selected and a fallback source is defined



AVB source is selected and no fallback source is defined



AVB source is in error and a fallback is defined and currently active for this DSP input



AVB source is ready to be re-enabled* and a fallback is defined and currently active for this DSP input



AES/EBU source is selected



Analog source is selected

*To clear the fallback, refer to [Fallback](#) (p.48).

Click the icon to access the individual DSP input page.

Input source selection

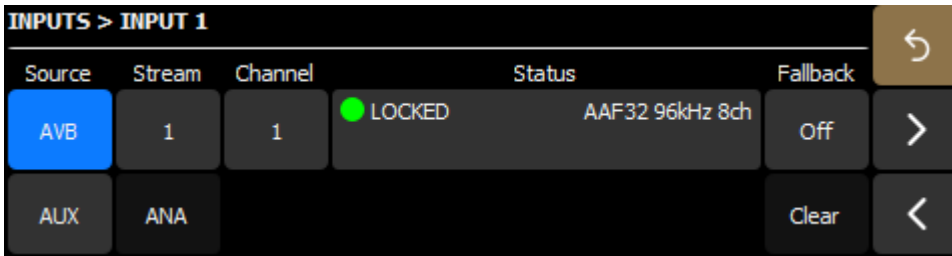

! Only input sources that are connected in LA Network Manager (Input Selector) are available. If an AUX input source is connected, the AUX mode can be changed in [AUX input settings](#) (p.54).

Define the source parameters for the DSP input:

Source	AVB or AUX
Stream	AVB: 1 to 16 AUX: AES or ANA
Channel	AVB: 1 to 8 AES: L or R ANA: not available

Signal status (AES and AVB)

The status of the signal is displayed in the **Status** column on each DSP input page. In redundant mode, the AVB status is prefixed by [P] for primary and [S] for secondary stream.

AES/EBU status



LOCKED and the sampling frequency
Indicates a digital audio source is connected to the AES/EBU input, the signal delivered by the source has a format supported by the controller's digital audio board, and no loss or fault is being detected during data transfer.

For example, LOCKED 96kHz indicates the digital audio source provides signals of sampling frequency of 96 kHz.

LOCKED - ERROR
Indicates the incoming digital signal has a sampling frequency that is out of the nominal range, but it does not lead to loss of audio.

LOCKED - INVALID
Indicates non-audio data in the payload or errors in the AES/EBU transmission.

UNLOCKED
Indicates the incoming digital signal is faulty and leads to loss of audio.
The LOCKED status is re-acquired after at least 500 ms of stability.

Input AVB status



Possible statuses when AVB is enabled:

IDLE	<p>The unit is not connected to any talker.</p> <p>If unexpected, possible cause is that an AVB controller requested a disconnection.</p> <p>To resolve, connect an AVB controller and use it to connect the unit to a talker.</p>
WAITING TLKR / WAIT TLKR / WTLK	<p>The listener has been told by an AVB controller to connect to a talker and it is now waiting for the talker to be online.</p> <p>If displayed for more than a few seconds:</p> <ul style="list-style-type: none"> • Check the network for a disconnected cable. • Check that the talker is in working order (fully booted).
CONNECTING / CING	<p>Temporary status while the listener waits for the talker to send information about the stream.</p>
CON TIMEOUT / CTMO	<p>Timeout has been reached while the listener waits for the talker to send information about the stream.</p> <p>Check that there are no issue on the network such as firewall parameters or Wi-Fi access points.</p>
CONNECTION ERROR / CON ERROR / CERR and error code	<p>While the listener waited for the talker to send information about the stream, the talker reported an issue.</p> <p>Refer to the List of AVB connection (CON) errors (p.76).</p>
WAITING RSV / WAIT RSV / WRSV	<p>The listener is waiting for the conclusion of the bandwidth reservation from the talker.</p>
RESERVATION ERROR / RSV ERROR / RERR and error code	<p>The bandwidth reservation has failed.</p> <p>It can also be temporarily displayed when a network cable is disconnected then reconnected.</p> <p>Refer to the List of AVB reservation (RSV) errors (p.74).</p>
WAITING START / WAIT START / WSRT	<p>The bandwidth is reserved but the unit has received a "stop streaming" command by the AVB controller: Try disconnecting and reconnecting the stream.</p>
WAITING DATA / WAIT DATA / WDAT	<p>Waiting for the talker to transmit the stream.</p> <p>If displayed for more than a few seconds, possible causes are:</p> <ul style="list-style-type: none"> • Talker is physically disconnected or off: check the talker. • A "stop streaming" command has been sent to the talker from a third-party AVB controller: Try disconnecting and reconnecting the stream.
DATA ERROR / DERR	<p>The listener is receiving the stream from the talker but the format is not as announced by the AVB controller.</p> <p>Check that the controller is sending the correct information.</p>
VALIDATING / VLDT	<p>The listener is receiving the stream from the talker, the stream has the correct format and the listener is verifying the validity of the time synchronization information from the stream before processing it.</p> <p>If displayed for more than a few seconds, check the number of hops in the network cabling.</p>
READY and the sampling frequency	<p>Processing of audio is suspended.</p> <p>Possible causes are: The input source on the amplified controller is selected as XLR or FBACK XLR. Select AVB to set the media clock.</p>

**WAITING MCLK /
WAIT MCLK /
WMCK**

The listener cannot process audio from this stream because the currently selected media clock source is not providing a valid clock.

Possible cause is: Non-Avnu certified devices on the network are disrupting the media clock synchronization. Preferably use Avnu-certified devices.

LOCKED / LCK
and the sampling
frequency

Processing audio stream data.

Fallback

Press **On** or **Off** to activate or deactivate fallback for the DSP input. On LA7.16, fallback only applies to AVB sources and automatically selects the corresponding channel on the AUX source connected.

In case of signal failure on one AVB stream with active mappings, the AVB Fallback Mode automatically switches to the AUX inputs as defined. The source status displays FALLBACK.

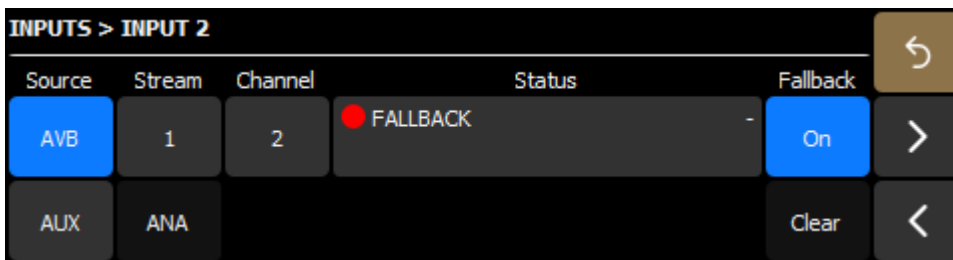

When the source is ready to be re-enabled, click **Clear** to switch back to the main source. This clears fallback for all DSP inputs connected to the same AVB stream.

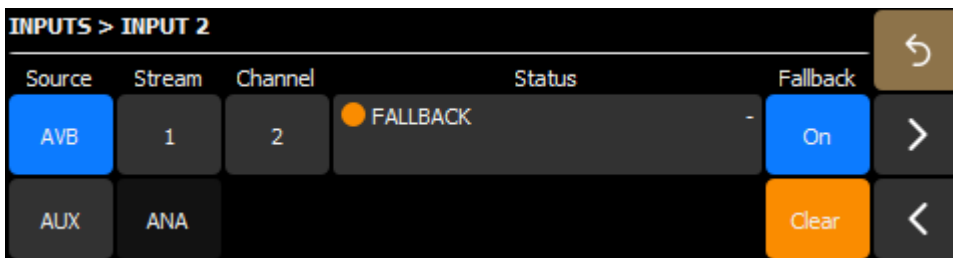

Using the menu



Open the menu (or push the encoding wheel from the main screen).

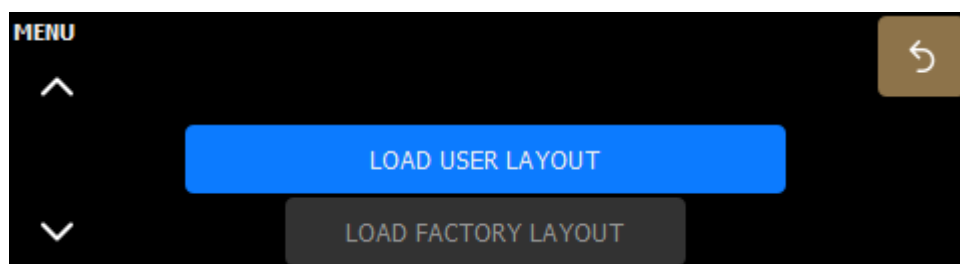

Use the encoding wheel or press the arrow buttons to navigate through the menu items.

Load user layout

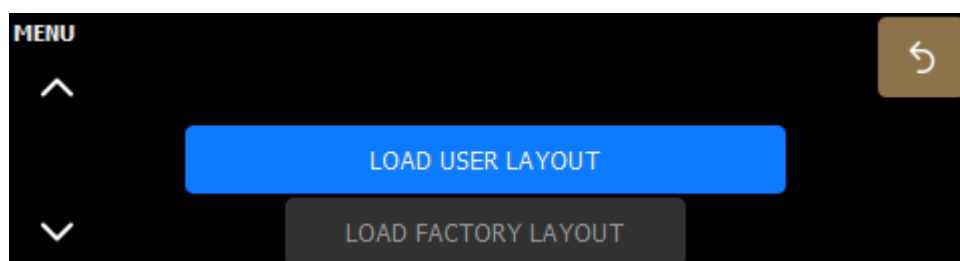

Load a layout created by a user from the device memory. Refer to [Store layout](#) (p.49).

Load factory layout

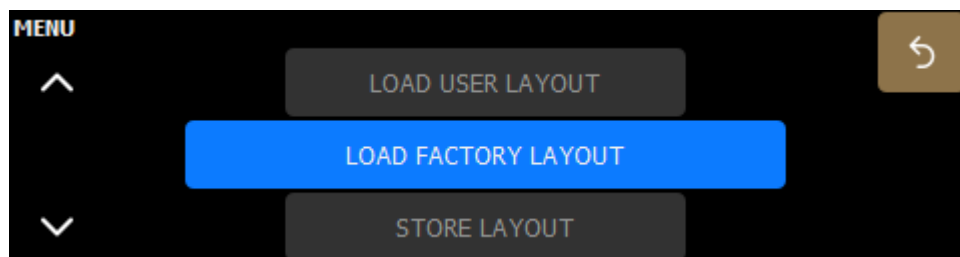

Load a factory layout created by L-Acoustics and installed during firmware update. The factory layout list can be found in the **Preset guide**.

Store layout

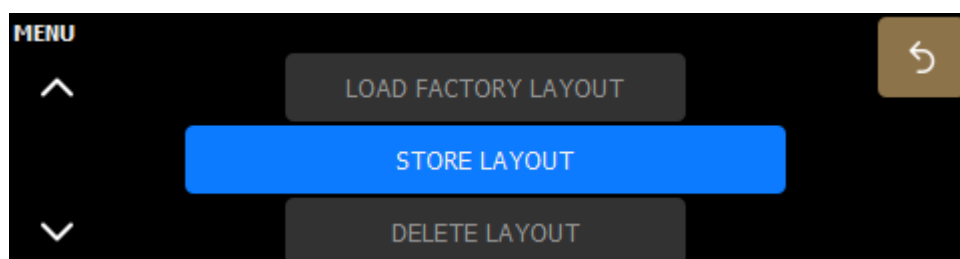

Save or overwrite a user layout in one of the ten slots in the device memory.

Delete layout

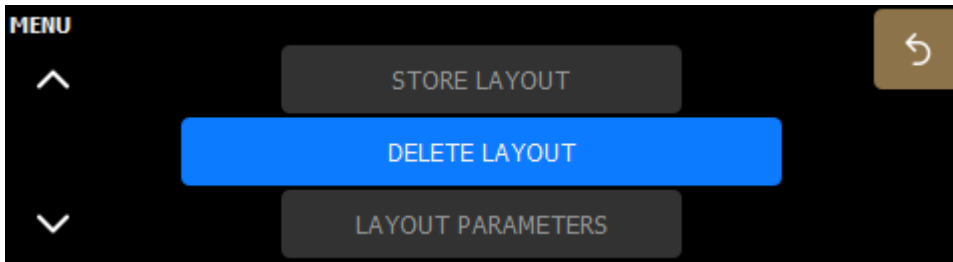

Delete a user layout from the device memory.



It is not possible to delete the layout that is currently used.

Layout parameters

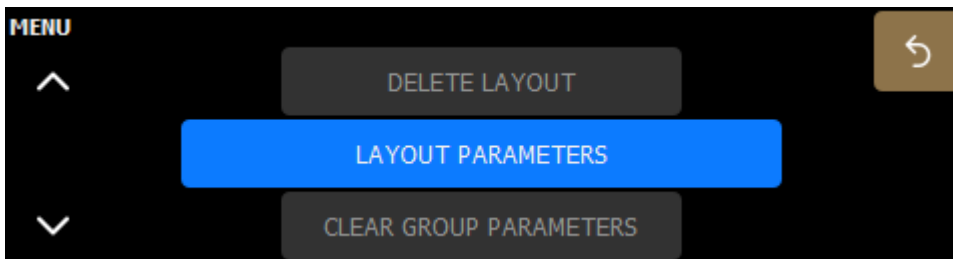

Layout parameters include polarity, delay, gain, and output routing.

Press the arrow buttons to navigate between the parameters.

Polarity

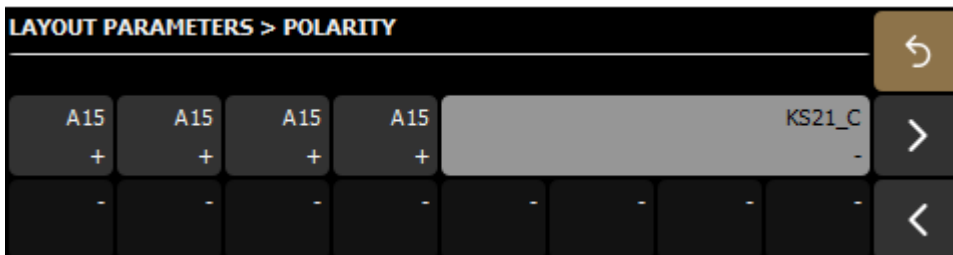

Press the enclosure set button to invert the polarity. Enclosure sets with negative polarity are displayed on a light gray background.

Delay (delay unit)

This page provides an overview of the delay of each enclosure set. To edit the delay, refer to [Editing gain or delay](#) (p.37).

The delay unit can be changed in [Preferences](#) (p.63).

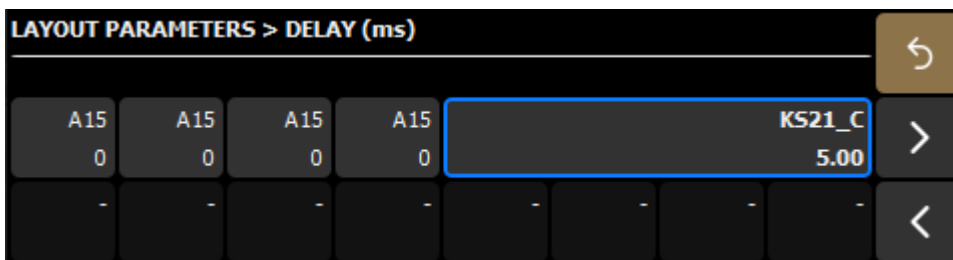

Gain (dB)

This page provides an overview of the gain of each enclosure set. To edit the gain, refer to [Editing gain or delay](#) (p.37).

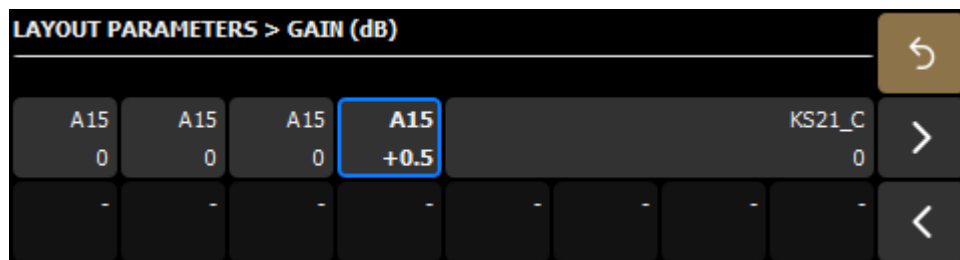

Output routing

This page displays the list of DSP inputs routed to each enclosure set.

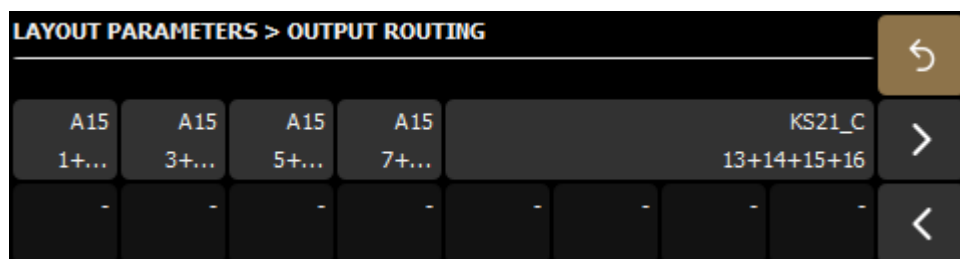

To change the routing, press the enclosure set button and select or deselect DSP inputs as needed. Routed DSP inputs are displayed on a blue background with a + (plus) sign.

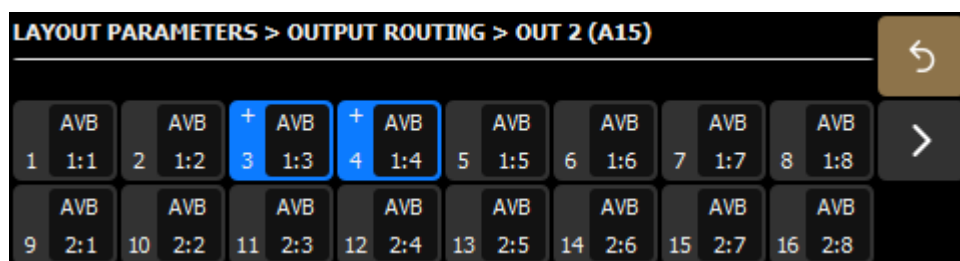

Clear group parameters

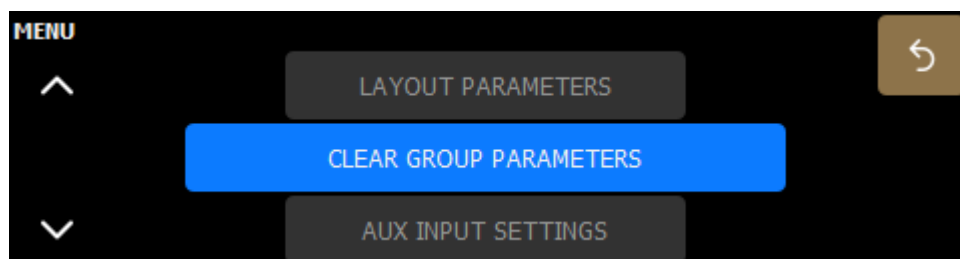

Group parameters (names, gains, delays, contour EQs) are defined in LA Network Manager and cannot be accessed from the amplified controller. They remain active when the amplified controller is disconnected from the computer running LA Network Manager (in standalone mode), and when the amplified controller is shut down or restarted. Group parameters are not layout-dependent and remain active when a different layout is loaded, on the output channels that were initially assigned to the group.

Therefore, it is recommended to clear group parameters when an amplified controller is used in standalone mode after being used within a network.

! Group parameters cannot be cleared when the amplified controller is remotely controlled by LA Network Manager.

After clearing group parameters, all output channels are muted.

Media clock

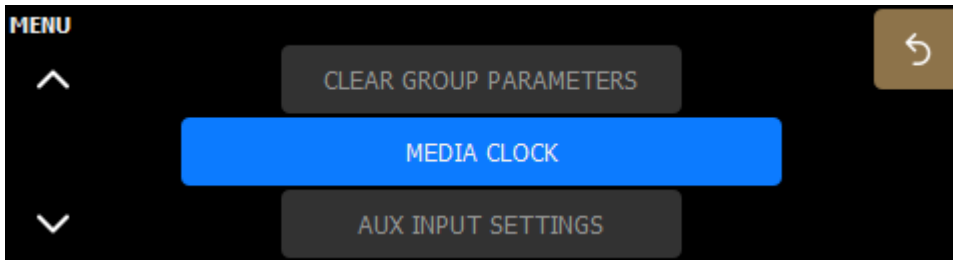

Configuring the Media Clock Source

Media Clock Source displays the current selected source of media clock used by the amplified controller, and its status. This selection may be edited.

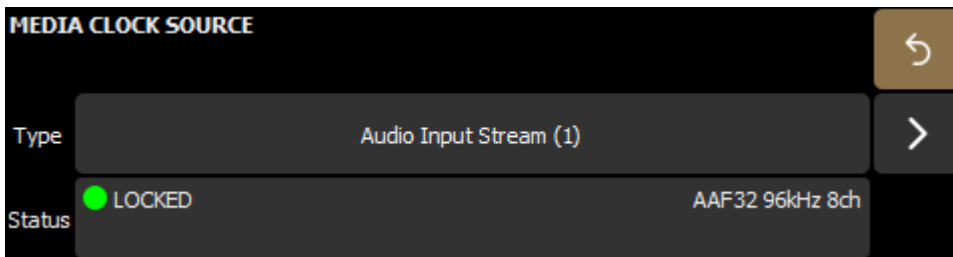

AVB redundancy mode

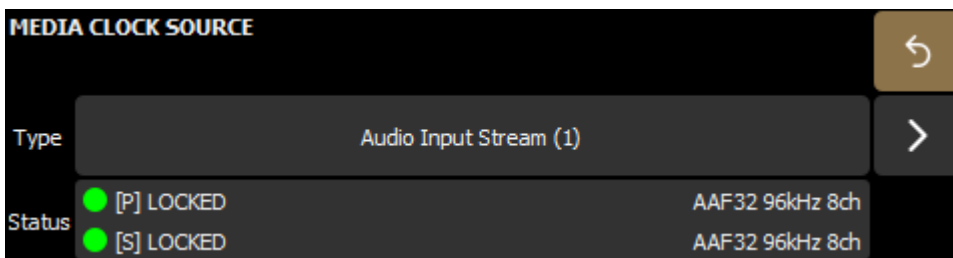

Media clock source type

Internal	The amplified controller clock runs using its high-precision internal quartz at 96 kHz.
Clock Input Stream	The amplified controller clock runs using the clock of the CRF input stream.
Audio Input Stream (1) - (16)	The amplified controller clock runs using the clock from one of the AVB audio input streams.

CRF (Clock Reference Format) streams only contain clock information, no media sample, for pre-synchronization (devices are locked before establishing the media streams). Refer to the **Avnu Pro Audio Media Clocking Specification** on avnu.org.

For input AVB statuses, refer to [Signal status \(AES and AVB\)](#) (p.46).

An orange AVB status dot in **LOCKED** status indicates a mismatch between the selected media clock source and the media clock used by the audio input streams. There are two ways to resolve it. Either:

- select the audio input stream as the media clock source (typical solution for smaller systems), or
- in large systems, designate one AVB device as the media clock master, connect its media clock stream to the clock input stream using LA Network Manager, and select the clock input stream as the media clock source.

Press the arrow buttons to navigate between **Media Clock Source** and **Media Clock Output**.

Media Clock Output

According to Milan specifications, LA7.16 provides a Media Clock Output stream that may be used as media clock reference for the other Milan-AVB devices of the network.

This view shows the status of the clock output stream(s).

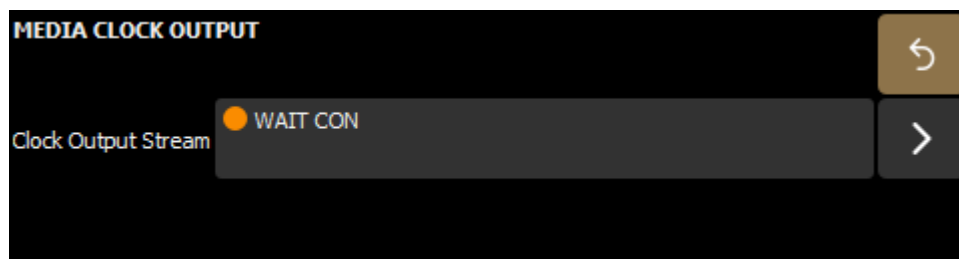

AVB redundancy mode

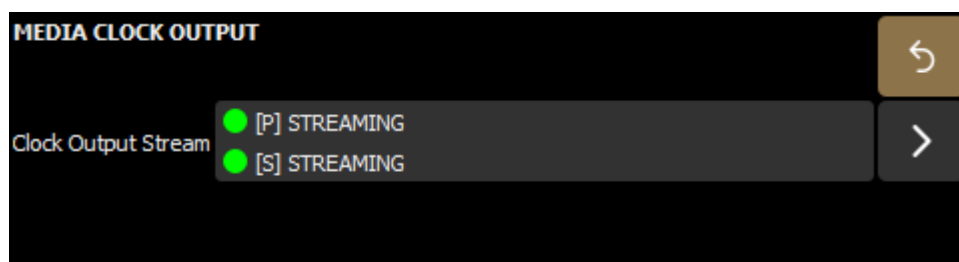

Output AVB statuses

IDLE	Temporary status at startup.
WAITING DSTAD	The talker is performing dynamic allocation of a Destination MAC Address for the output stream. If unexpected, check the network for faulty devices.
WAIT CON	The talker is ready to receive a connection request from a listener. If unexpected: use an AVB controller to check that a listener has been instructed to connect to the talker.
WAIT REUSE	The talker has received a connection request but needs to wait (max. 30 seconds) for the SRP protocol to release a previous reservation for the stream, because of a change in the stream format or stream latency.
WAIT RSV	The talker is waiting for the conclusion of the bandwidth reservation from a listener. If displayed for more than a few seconds: <ul style="list-style-type: none"> • Check the network for a disconnected cable. • Check that the listener is in working order (fully booted).
RESERVATION ERROR	The bandwidth reservation has failed. It can also be temporarily displayed when a network cable is disconnected then reconnected. If displayed for more than a few seconds, check the List of AVB reservation (RSV) errors (p.74).
READY and the sampling frequency	Waiting for media clock to set up. If displayed for more than a few seconds, possible cause is: Non-Avnu certified devices on the network are disrupting the media clock synchronization. Preferably use Avnu-certified devices.
STREAMING and the stream format	Sending audio stream data.

AUX input settings

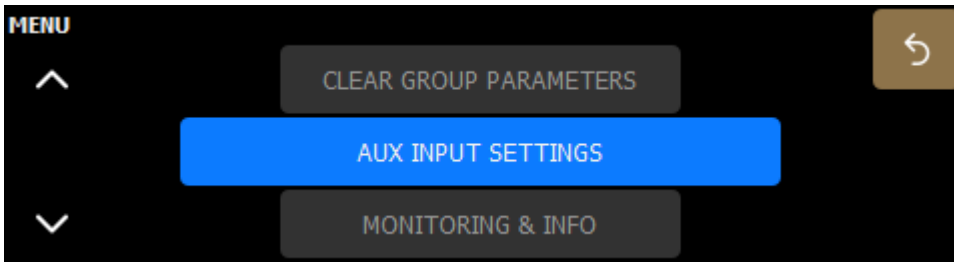

Change the AUX Mode and select the analog input gain.

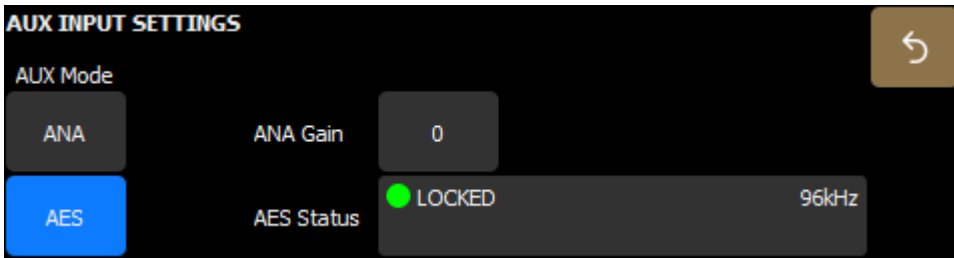

Monitoring & info

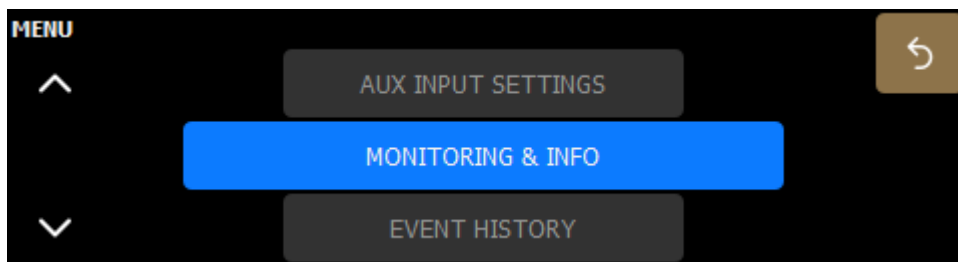

Access to information about the device and troubleshooting.

General

Select **MONITORING & INFO > GENERAL**.

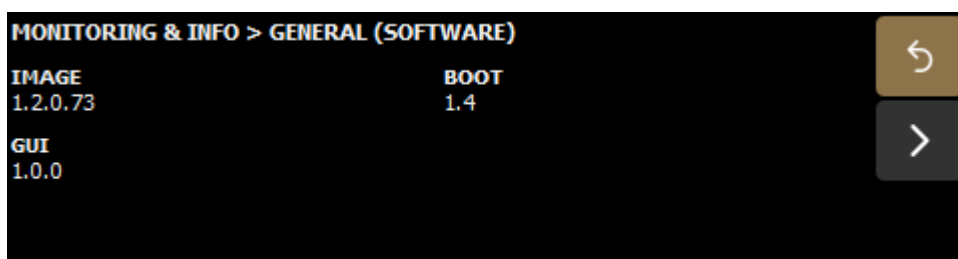
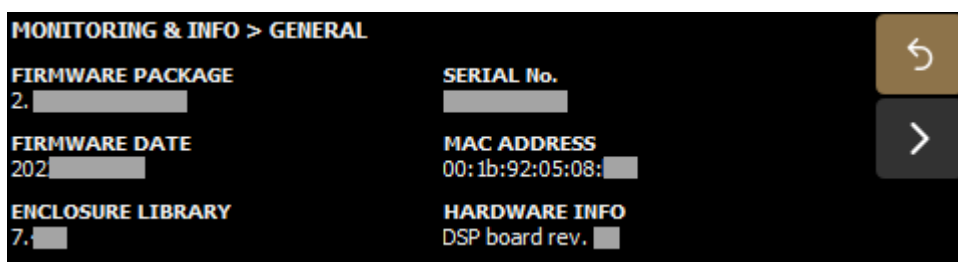
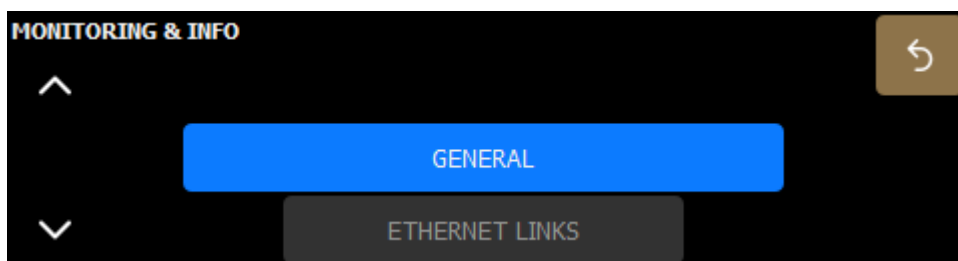

For troubleshooting purposes, it can be useful to communicate this data to your L-Acoustics representative.

Item	Format	Comment
Firmware Package	4 digits separated by periods example: 2.13.0	
Firmware Date	YYYYMMDD example: 20230101	
Enclosure Library	3 digits separated by periods example: 7.5.0	
Serial No.	10-digit number	
MAC Address	6 pairs of hexadecimal digits separated by colons example: 5E:FF:56:A2:AF:15	The MAC address (Media Access Control) is a unique international identification number.

Item	Format	Comment
Hardware Info	1-digit number example: DSP board rev. 8	
Software		
Image	4 digits separated by periods example: 1.2.0.73	
GUI (Graphical User Interface)	3 or 4 digits separated by periods example: 1.0.0.41	
Boot	2 digits separated by periods example: 1.4	

Ethernet links

Select **MONITORING & INFO > ETHERNET LINKS**.

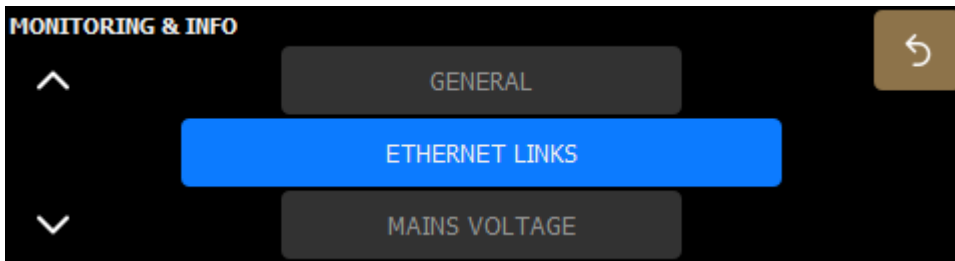

The screenshot shows the 'ETHERNET LINKS' status page. It has a title 'MONITORING & INFO > ETHERNET LINKS' and a back arrow in the top right. The data is presented in a table:

	LINK 1	LINK 2
STATE	UP	DOWN
SPEED	1 Gbit/s	-
DUPLEX	FULL	-

State UP/DOWN

Possible causes of a DOWN state:

- No cable connected to the port.
- Faulty cable connected to the port.
- Cable connected to the port but no device connected at the other end of the cable.
- Port failure.

Speed 10 Mbits/s, 100 Mbits/s, or 1 Gbits/s

Duplex Half/Full

Mains voltage

Select **MONITORING & INFO > MAINS VOLTAGE**.

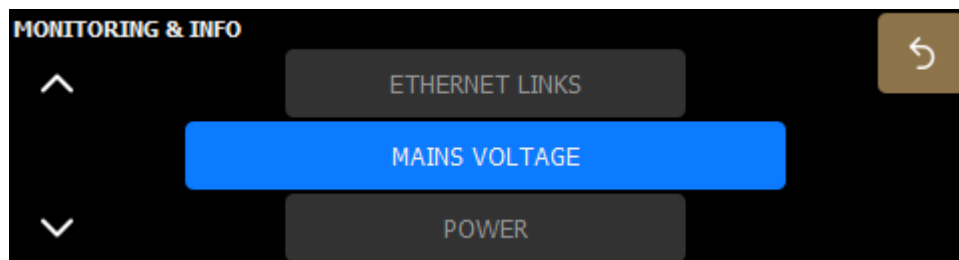

Mains voltage (V) displays the minimum, average, and maximum voltage of the connected power supply, measured over the past 1.5 seconds, to help visualize if the power supply is undersized or if drops in voltage are occurring.

Ideally, the average value should correspond to the power supply nominal voltage, and minimum and maximum values should not exceed $\pm 10\%$ of the nominal voltage.

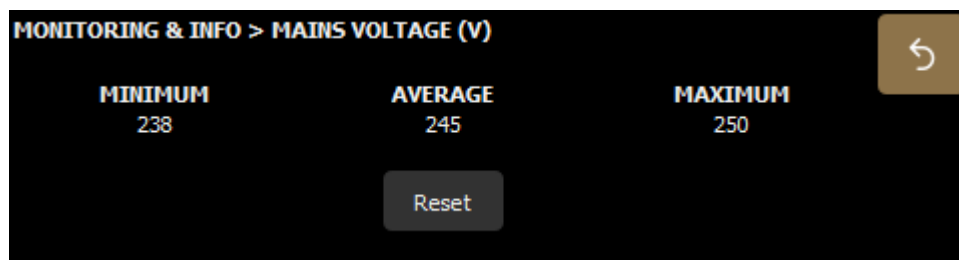

For example, in this illustration, the average is 245 V, minimum is 238 V, and maximum is 250 V.

To reset the measurement, press **Reset**.

Power

Select **MONITORING & INFO > POWER**.

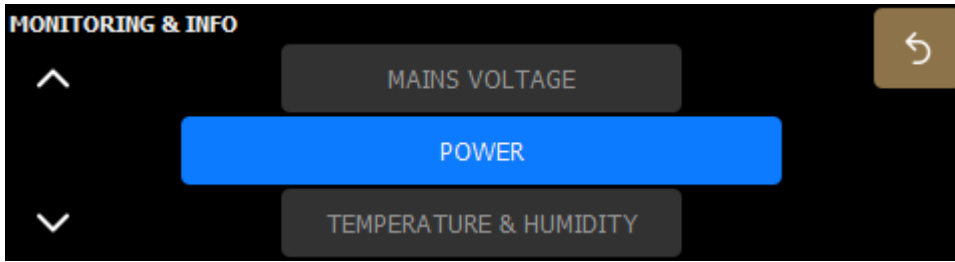

Power budget

This page represents an estimation of the consumption of the amplified controller's power budget considering the requirements of the presets in the current preset layout.

The power gauge at the top represents the overall percentage and each enclosure set displays its individual percentage.

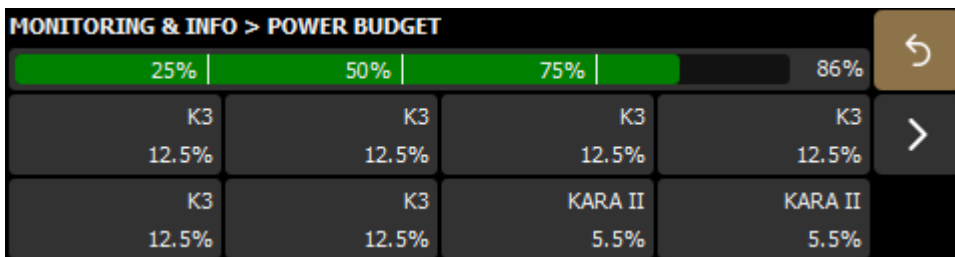

Power gauge color

green	below 100%
orange	between 101% and 150%
red	above 150%

Power monitoring

This page displays the power headroom and the gain reduction applied by the limiters.

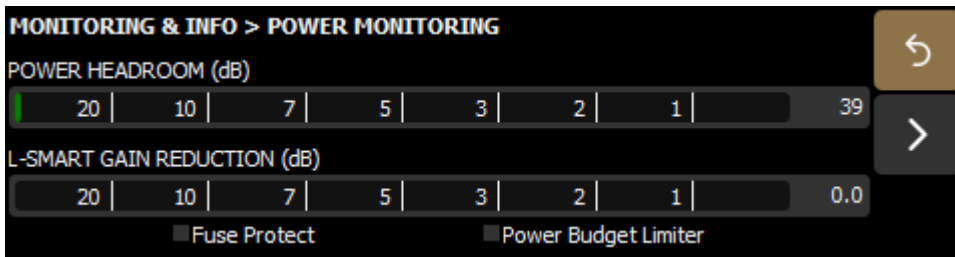

Power Budget Limiter

Protection mechanism that triggers a temporary moderate attenuation of all output channels when the real-time power consumption exceeds the amplified controller's power budget.

For instance, 1.8 dB for a real-time power consumption of 150% of the power budget.

Fuse Protect

Protection mechanism that triggers an attenuation of the signal delivered at the output channels when power supply is challenged by the power demand of the unit, in order to prevent the circuit-breaker from tripping.

When a limiter is active, the corresponding LED lights up and the **L-SMART Gain reduction (dB)** gauge displays the gain reduction:

- When the Power Budget Limiter is active, the gauge is orange.
- When the Fuse Protect is active, the gauge is red.

Temperature & Humidity

Select **MONITORING & INFO > TEMPERATURE & HUMIDITY**.

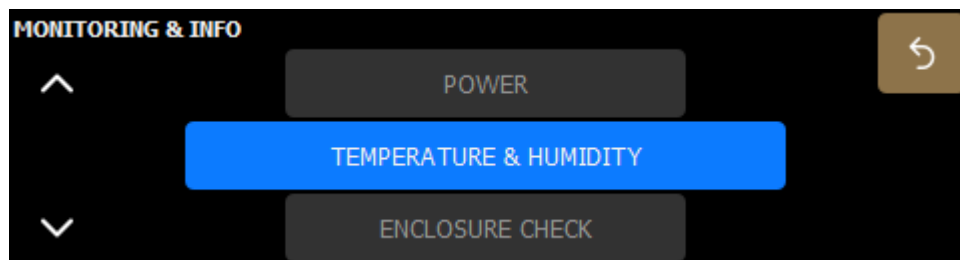

The values are displayed on a color-coded background to indicate if LA7.16 is at risk of overheating.

background color	percentage of maximum temperature
green	up to 70%
orange	71% to 75%
red	75% and more

Channel temperatures

The temperature and humidity of each output channel.

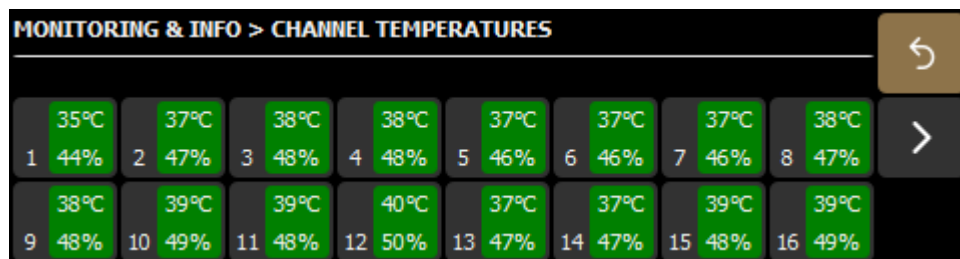

Device temperature and humidity

The temperature and humidity measured from inside the device.

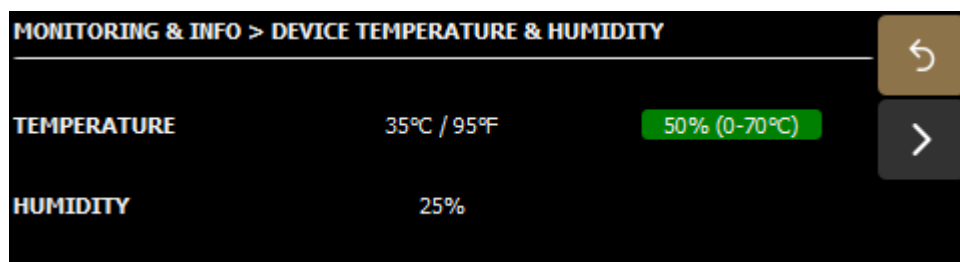

Enclosure check

Select **MONITORING & INFO > ENCLOSURE CHECK**.

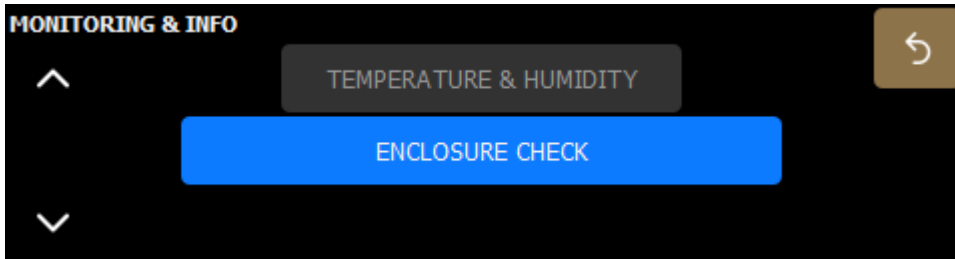

Enclosure check is a preliminary diagnosis tool for the loudspeaker enclosures connected to the amplified controller. It measures the impedance at the reference frequencies for the connected loudspeaker family. The measured impedance is compared to the expected range allowing for fast detection of loudspeakers presenting circuit continuity issues.

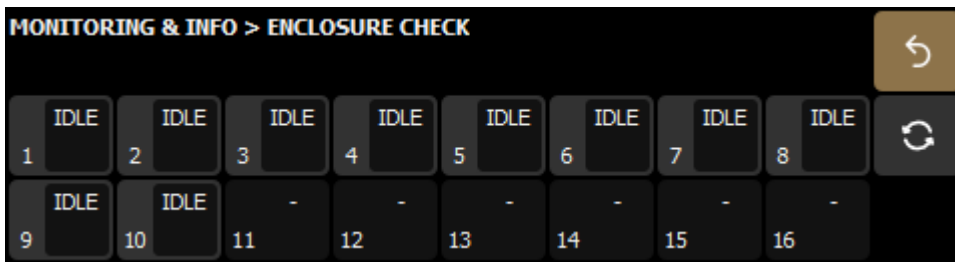

Press  to launch the test. After a few seconds, each channel displays its status.

Enclosure check status

IDLE	impedance is not measured
OK	measured impedance is within expected range
NOK	measured impedance is not within expected range
NC	not connected
?	unsupported preset family
UNDF	measured impedance is undefined

 For status NOK, NC, or UNDF, refer to the **Enclosure check** technical bulletin for troubleshooting instructions.

Event history

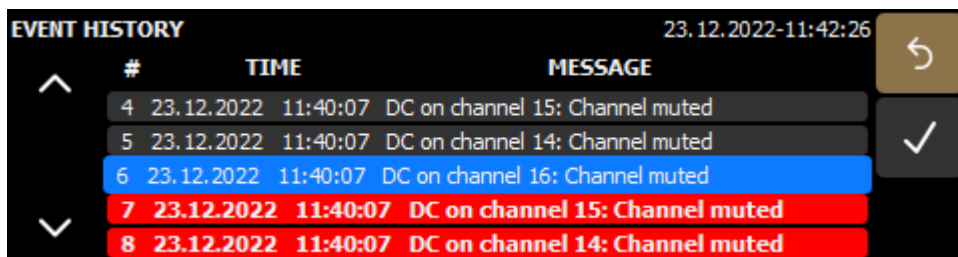
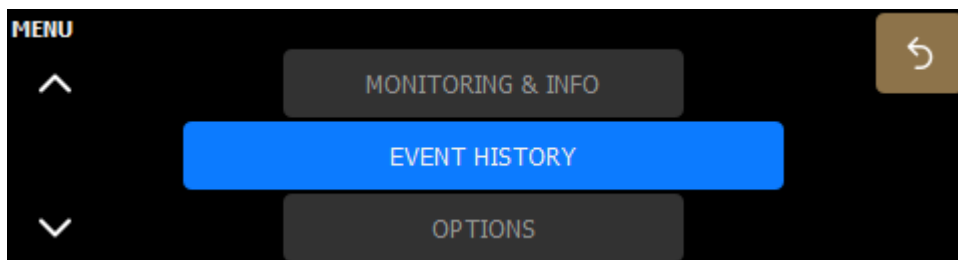

The Event history page displays the events since starting up the amplified controller from the newest to the oldest. Events

can be acknowledged by clicking .

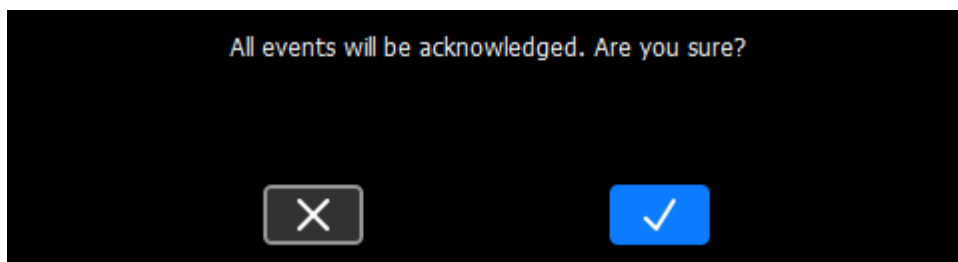

When an event occurs, a warning symbol is displayed next to the IP address on the main screen. The icon disappears when the events are acknowledged.

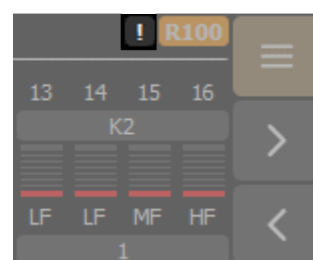
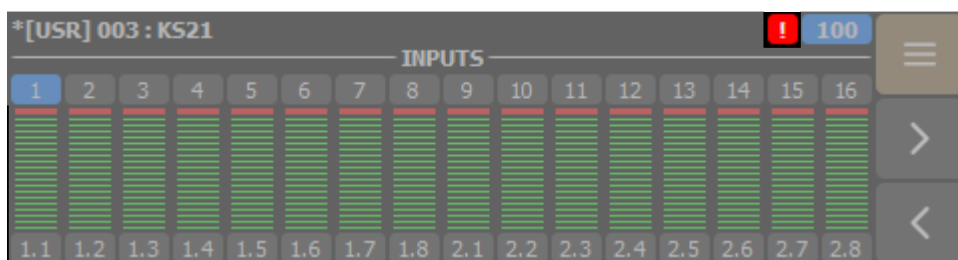

The warning symbol has different level criteria characterized by different colors:

- red for critical or major level
- grey for minor level or information

Level criteria

Levels	Impact on live show	Duration	Solution
Info	does not compromise a live show	N/A	N/A
Minor	does not compromise a live show	N/A	automatic or manual
Major	can compromise a live show	< 1 minute	automatic or manual
Critical	can compromise a live show	> 1 minute	manual

Options

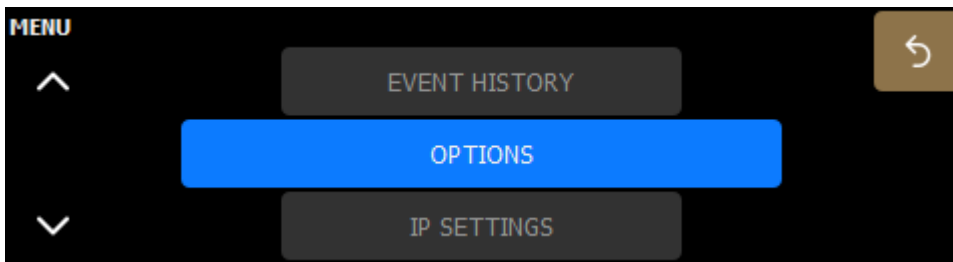

Network switch

Select **OPTIONS** > **NETWORK SWITCH**.

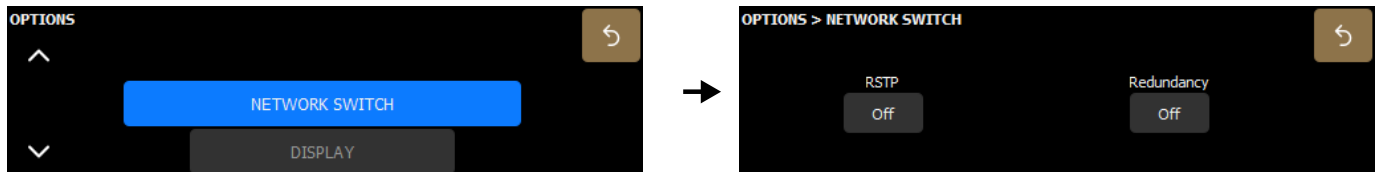

Rapid Spanning Tree Protocol

Off / On

The Rapid Spanning Tree Protocol (RSTP) is used to detect and automatically disable Ethernet ports to break loops created by redundant links in the network, which avoid broadcast storms that cause network failure.

In case of a cable or switch failure in the network, the protocol re-enables these ports to restore connectivity.

! Always enable Rapid Spanning Tree Protocol when using redundancy mode.

Redundancy

Turn off/on redundancy mode.

Off / On

When redundancy mode is enabled, LA7.16 no longer operates as an AVB bridge: the two Ethernet ports are independent with their own IP address. LA7.16 can receive and distribute two parallel AVB streams on two separate networks, one primary and one secondary, for seamless backup in case of failure.

i Refer to the **LA Network Manager** Help for detailed instructions (in section **User guide** > **General**).

Enabling or disabling redundancy mode restarts the device.

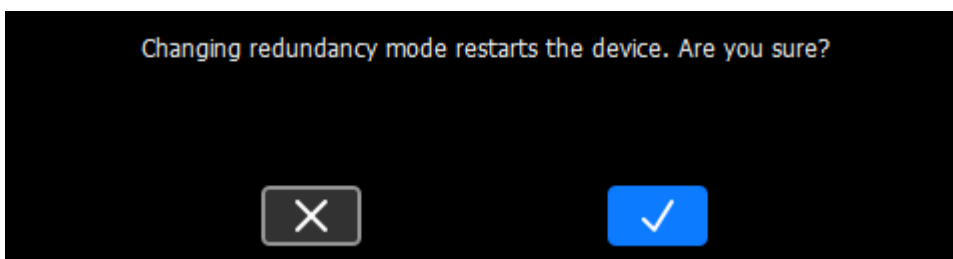

On the main screen, **R** is displayed next to the IP address when redundancy mode is enabled.

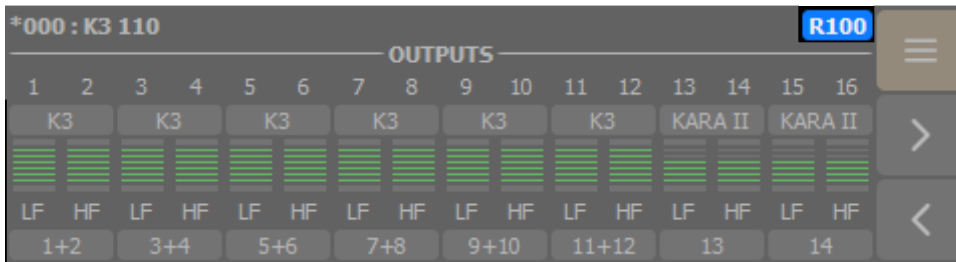

Display

Select **OPTIONS > DISPLAY**.

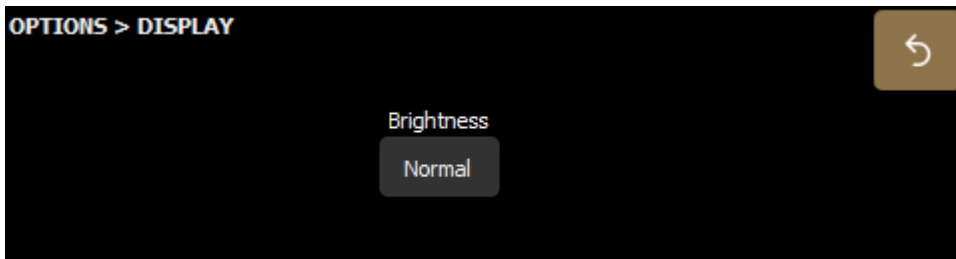
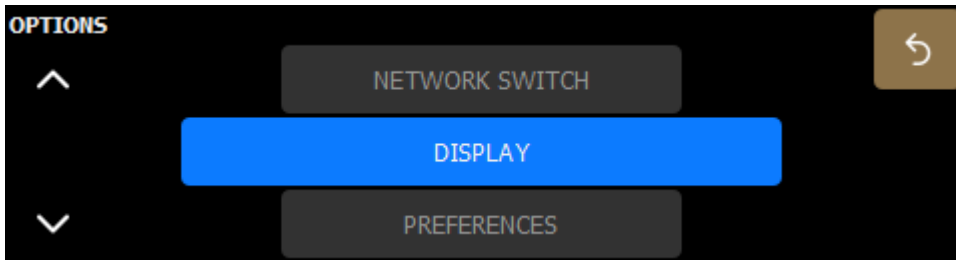

The levels of brightness are: High, Normal, Medium, Low, and Off.

Turning off the display is applied after a confirmation. To turn the display back on, use LA Network Manager: in the **Setup** page, select **Status > LED & Backlight Mode**.

Preferences

Select **OPTIONS > PREFERENCES**.

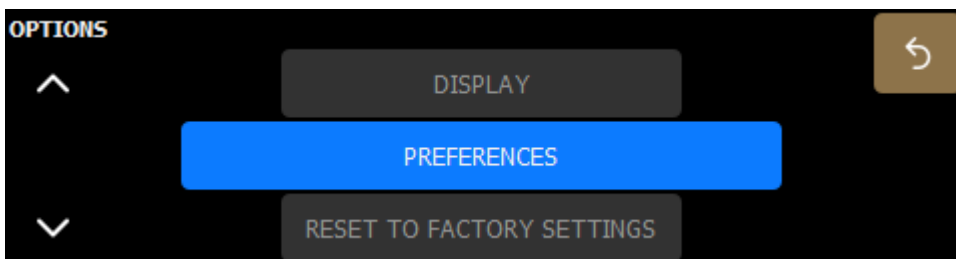

Change the default preferences for selection and delay unit.

- | | |
|----------------------|------------------------------|
| Gain/Delay Selection | Additive or Exclusive |
| Delay Unit | ms, Samples, Meters, or Feet |

Reset to factory settings

Select **OPTIONS** > **RESET TO FACTORY SETTINGS**.

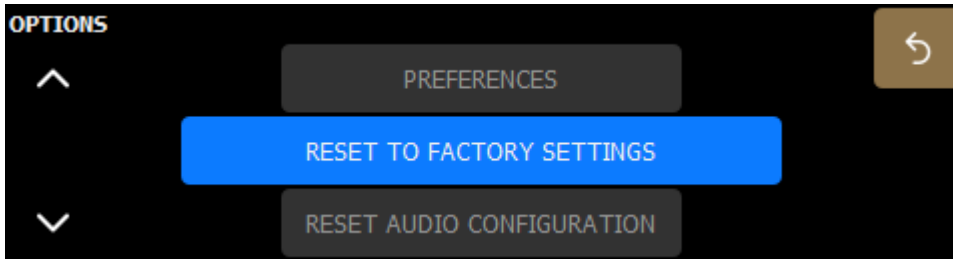

! Disconnect the amplified controller from the L-NET network or switch LA Network Manager to offline mode before resetting.

Reset the amplified controller to factory default settings and delete all data. After a confirmation screen, the amplified controller reboots and the first factory layout is loaded.

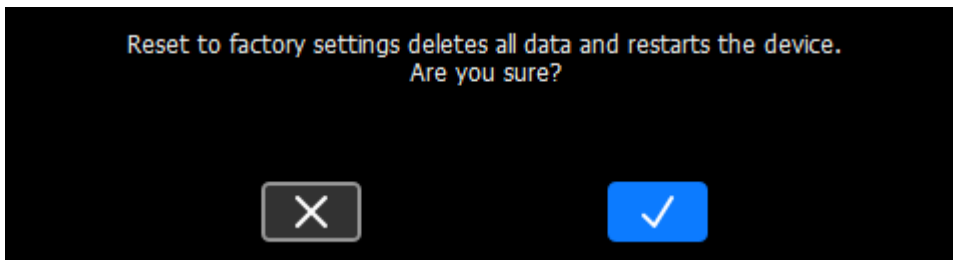

Reset audio configuration

Select **OPTIONS** > **RESET AUDIO CONFIGURATION**.

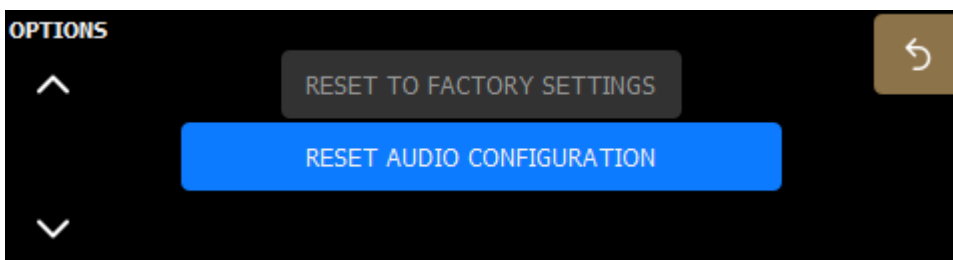

! Disconnect the amplified controller from the L-NET network or switch LA Network Manager to offline mode before resetting.

The audio configuration of the amplified controller can be reset. This includes the following parameters:

- Input settings:
 - Input source(s)
 - Stream mapping
 - AUX input mode
 - Fallback
- Group parameters
- User layouts

After a confirmation screen, the amplified controller reboots and the first factory layout is loaded.

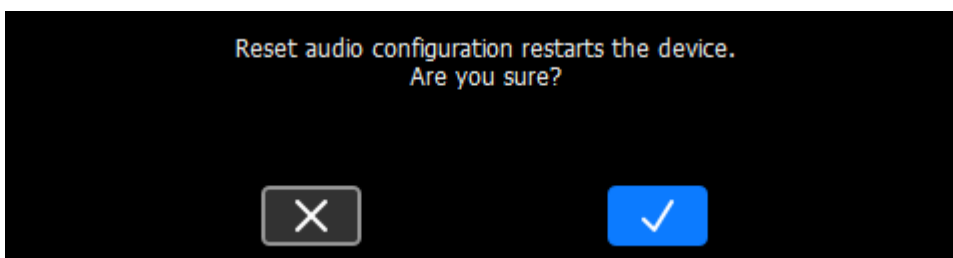

IP settings

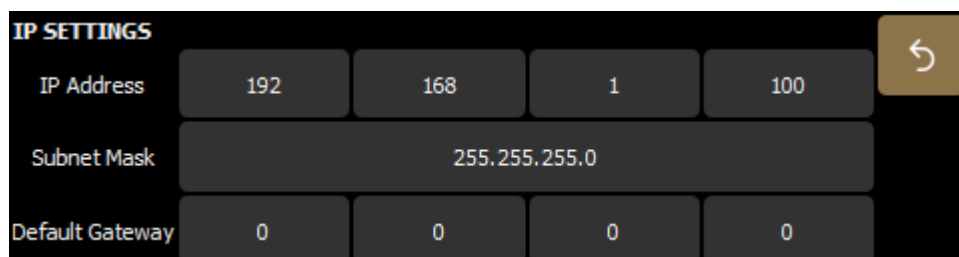
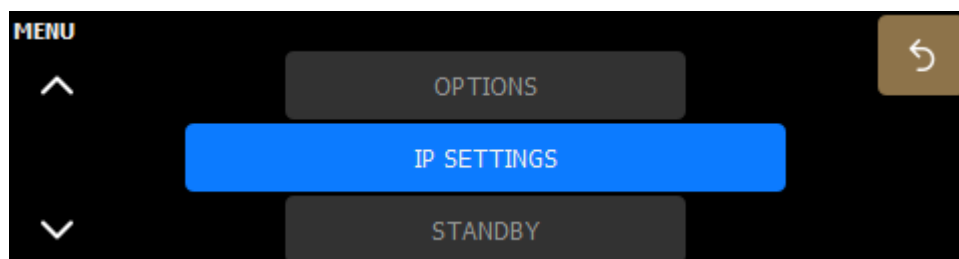

With redundancy enabled:

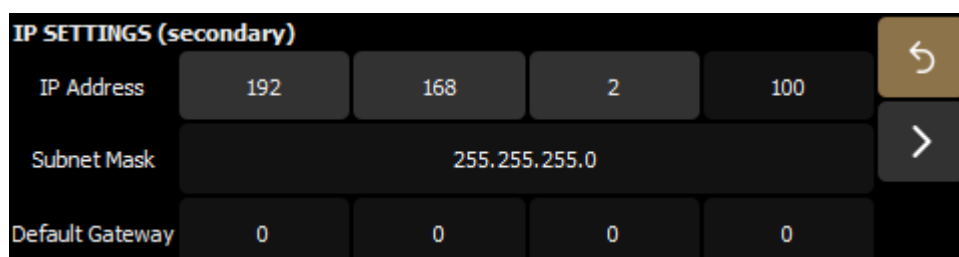
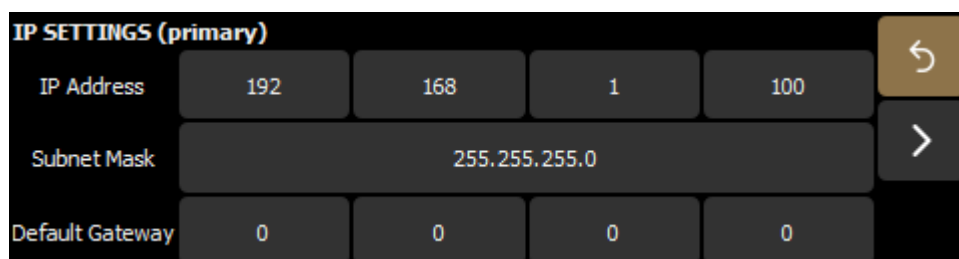

Remote control of processors and amplified controllers requires setting up a private local area Ethernet network to interconnect up to 253 units (and additional devices such as Ethernet switches / AVB bridges) with a single control computer. This Ethernet network, called L-NET, uses L-COM PROTOCOL, a proprietary communication protocol based on TCP/IPv4.

An IP address is a unique identifier for a network device on a given IP network. In IPv4 networking, it is made of 4 bytes (32 bits). An IP address is composed of a subnet address and a host address. The host address serves as a unique device identifier on the subnet. The subnet mask determines how many bits define the subnet address, and how many define the host address.

By convention, the first possible number of the host address is reserved to designate the subnet, and the last number is reserved to communicate with all devices of the subnet (IP broadcast address).

The factory default IP settings of all L-Acoustics devices are:

- IP address: 192.168.1.100
- Subnet address: 192.168.1.0/24
- IP broadcast address: 192.168.1.255
- Subnet mask: 255.255.255.0

With these settings, the first three bytes of the IP address (192.168.1) define the subnet address, and the last byte is the host address (100).

In general, it is recommended to:

- Use the default subnet address and subnet mask.

- Edit the device host address to provide a unique identifier to each unit: use consecutive IP addresses starting from 192.168.1.**1** up to 192.168.1.**253**.
- Set the control computer to 192.168.1.**254**.

However, it is possible to configure other IP settings when required by network administration. Subnet mask may be defined from 255.0.0.0 to 255.255.255.0, and the IP and gateway addresses must both belong to one of the following IP ranges (standards for Private Local Area Networks):

- 10.0.0.1 to 10.255.255.254
- 100.64.0.1 to 100.127.255.254
- 172.16.0.1 to 172.31.255.254
- 169.254.0.1 to 169.254.255.254 (not recommended)
- 192.168.0.1 to 192.168.255.254

 **LA Network Manager and its host computer must be using the same subnet and Subnet mask as the units.**

In AVB redundant mode, the host address is always made identical for both the Primary and the Secondary network. The subnet address of the Secondary network is that of the Primary + 1. For example, with default settings:

- Primary port: 192.168.**1**.100
- Secondary port: 192.168.**2**.100

The subnet mask setting always applies to both networks. When using smaller subnet masks, the host address is also made identical. For example:

- Primary port: 172.**16**.1.100
- Secondary port: 172.**17**.1.100

The Gateway address is only available for the Primary network.

Configuring the IP settings

 **LA Network Manager and its host computer must be using the same subnet and Subnet mask as the units.**

Make sure that:

- The IP address is included in one of the supported IP ranges.
- The gateway is set to an IP belonging to the same subnet, or is set to 0.0.0.0 if not used.

IP address

Values for the first byte (first number) are restricted to Private Local Area Network prefixes: 10, 100, 169, 172, and 192.

For the first three bytes, set all Units of a system to the same values (for instance 192.168.1) for remote control by LA Network Manager.

Subnet mask

The widest subnet mask that can be used is 255.255.255.0.

Wider subnet masks, such as 255.255.255.128, are not supported.

Gateway

A gateway IP address is an advanced setting reserved for specific applications such as amusement parks, campuses, and multi-room venues with a centralized third-party supervision tool (SNMP, Crestron, Extron, Q-SYS). In such contexts, the supervision tool is often located in a different subnet that is interconnected with the subnets of the units. Interconnection is achieved thanks to a gateway. The gateway address must be set on the units to enable communication with the supervision tool.

 If the first byte of the gateway IP address is set to 0, the three other bytes are reset to 0 upon validation.

Standby

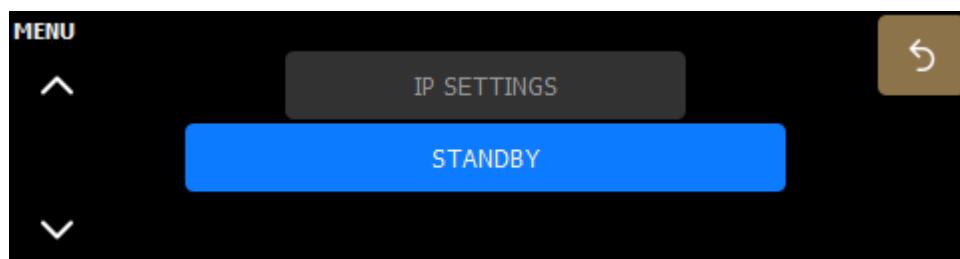

Set the unit to standby mode.

When LA7.16 is in standby, press the encoder wheel for 1 second to set it to operating mode, or change the unit status in LA Network Manager.

Identifying LA7.16

When LA7.16 is connected to the L-NET network, it is possible to identify it among other amplified controllers on the Workspace of LA Network Manager, and conversely in the physical setup.

During identification:

- On the Workspace of LA Network Manager, the identified LA7.16 blinks in yellow.
- On the identified LA7.16, the screen displays the complete IP address on a blinking yellow background.

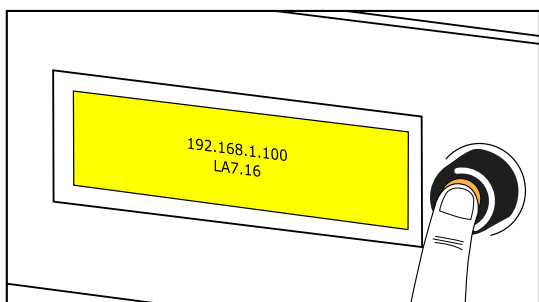

To identify a unit on the Workspace of LA Network Manager, press and hold for two seconds the encoding wheel from the **Inputs** or the **Outputs** menu.

To identify a unit in the physical setup, refer to the **LA Network Manager Help**.

Specifications

Specifications

All values given in this section are typical values.

General

Output power

12 dB Crest Factor 2 ms, 1 kHz, all channels driven, sine burst	16 × 700 W peak (at 16 Ω) 16 × 1300 W peak (at 8 Ω) 16 × 1100 W peak (at 4 Ω)
CEA-2006 / 490A 20 ms, ≤ 1% THD, 1 kHz, all channels driven, sine burst	16 × 580 W RMS (at 16 Ω) 16 × 920 W RMS (at 8 Ω) 16 × 1000 W RMS (at 4 Ω)
Maximum peak output voltage	152 V pk (loaded 8 Ω, single sine wave 1 kHz)
Amplification class	High-efficiency Class D
Digital Signal Processor (DSP)	Gen. 5 dual SHARCs 32-bit, floating point, 96 kHz sampling rate
Frequency response 20 Hz - 20 kHz	± 0.05 dB
Distortion THD+N	< 0.1% (20 Hz - 20 kHz, 8 Ω load, 60 W output power)
Output dynamic range (Digital input)	> 119 dB (20 Hz - 20 kHz, 8 Ω, A-weighted)
Amplification gain	32 dB
Noise level (Digital input)	< -79 dBV (20 Hz - 20 kHz, 8 Ω, A-weighted)
Channel separation	> 65 dB (at 1 kHz, 8 Ω, 60 W)
Damping factor	500 (20 Hz - 1 kHz, 8 Ω load)
Output delay	0 ms to 1000 ms

Mains input power and current draw (all channels driven)

Maximum output power (CEA-2006 / 490A 20 ms, ≤ 1% THD, 1 kHz, all channels driven, sine burst)	16 × 580 W at 16 Ω	16 × 920 W at 8 Ω	16 × 1000 W at 4 Ω
1/3 output power (-5 dB)	16.9 A / 3800 W	18.6 A / 4200 W*	19.2 A / 4300 W*
1/8 output power (-9 dB)	6.7 A / 1500 W	11.2 A / 2500 W	13 A / 2900 W

! * 1/3 output power measurements given for 11 channels (8 Ω) and 10 channels (4 Ω) loaded using the same signal simultaneously.

For more channels using the same signal simultaneously, the amplified controller will reduce output power below 1/3 output power.

Current values given for mains rated at 230 V. Multiply by:

- 2.3 for 100 V
- 1.92 for 120 V
- 1.15 for 200 V

Mains input power and current draw in Idle and Standby modes

	230 V	120 V	100 V
Idle	1.0 A / 140 W	1.3 A / 140 W	1.4 A / 140 W
Standby	0.8 A / 19 W	0.5 A / 19 W	0.5 A / 19 W

Power supply

Model	universal Switched Mode Power Supply (SMPS) with power factor correction (PFC)
Power factor	> 0.95 (at full load)
Mains rating	100 V AC - 240 V AC \pm 10%, 50 Hz - 60 Hz, 2800 W
Nominal current requirements	30 A for 100 V AC - 120 V AC, 16 A for 200 V AC - 240 V AC
Connector	32 A powerCON

Operating conditions

Temperature	-5 °C / 23 °F to 50 °C / 122 °F
Maximum altitude	2000 m

Protection

Mains and power supply	<ul style="list-style-type: none"> over and under voltage over temperature
	<ul style="list-style-type: none"> L-SMART <ul style="list-style-type: none"> overcurrent (fuse protection, and inrush current protection) power budget limiter
Power outputs	<ul style="list-style-type: none"> over current DC short circuit over temperature
Transducers protection	<ul style="list-style-type: none"> L-DRIVE <ul style="list-style-type: none"> excursion temperature over-voltage
Cooling system	fans with temperature-controlled speed
Fan noise (free field, 1 m)	<ul style="list-style-type: none"> at minimum speed: 33 dBA at maximum speed: 65 dBA

Interface and connections

Display	1 TFT color touchscreen display (480 × 128 px)
Navigation	1 encoding wheel with push button
Output connectors	1 SC32 female connector
L-NET connectors	2 × 1 Gb/s Ethernet etherCON® I/O
Service port	1 USB Micro-B, 2.0 compliant - for configuring IP settings using the USB Terminal tool of LA Network Manager.

Input signal distribution

Interface and connections

Routing and summation matrix	16 × 16
Input	1 for analog or AES/EBU on the rear 12-point terminal block
Link	1 for Analog or AES/EBU on the rear 12-point terminal block

Digital input

Supported digital input format

Standards	AES/EBU (AES3)
Sampling frequency (Fs)	44.1, 48, 88.2, 96, 176.4, or 192 kHz
Word length	16, 18, 20, or 24 bits
Synchronization	signal resampled to internal clock at 96 kHz

Sample Rate Converter (SRC)

Sampling frequency	96 kHz (SRC referenced to the amplified controller internal clock)
Word length	24 bits
Dynamic range	140 dB
Distortion THD+N	< -120 dBFS (dB Full Scale)
Bandpass ripple	±0.05 dB 20 Hz - 40 kHz, 96 kHz

Input gain

Range	-12 dB to +12 dB
Steps	0.1 dB

Latency

Analog and AES/EBU

In standard operating mode	3.84 ms (independent from input Fs)
In low latency operating mode	1.18 ms (independent from input Fs)

Milan-AVB

Featured AVB entities	MILAN™-compliant, Avnu™-compliant Milan-AVB Bridge and Listener
Standards	Ethernet Milan-AVB: IEEE 802.1BA-2011 Transport: IEEE 1722-2016 (AVTP) Control: IEEE 1722.1-2013 (AVDECC)
Input audio stream	Number: 16 (in normal or redundancy mode) Class: A Maximum network latency: 2 ms Formats: AAF PCM32, up to 8 channels, at 48 kHz or 96 kHz IEC 61883-6 AM824, 8 channels, at 48 kHz or 96 kHz

Media clock	upon user selection: synchronized on clock of the connected AVB input stream (upsampling at 96 kHz in case of stream at 48 kHz) synchronized on clock of the connected CRF stream internal
Streams forwarded by AVB Bridge	up to 150

Automatic fallback option

Mode	AVB to AES or analog, with user-defined mapping
Switchover conditions	AVB: loss of lock
Constant delay	independent from input Fs
Constant level	upon manual user selection of gain, independent from input Fs
Revert to initial input	upon manual user selection

Remote control and monitoring

Network connection	dual-port Ethernet Gigabit interface
Network redundancy	RSTP
General Purpose I/O (GPIO)	3 GPIO, isolated Optocoupler Inputs, isolated Relays Contacts, available on the 12-point terminal block
External DSP backup voltage input	1 × 24 V DC ($\pm 15\%$) 17 W maximum
L-Acoustics remote control software	LA Network Manager version beta 3.3.0
Third-party management solutions	Crestron [®] , QSC Q-SYS

Crestron is a trademark or registered trademark of Crestron Electronics, Inc. in the United States, other countries or both.

QSC[®] and Q-SYS[™] are trademarks or registered trademarks of QSC, LLC in the U.S. Patent and Trademark Office and other countries.

Physical data

Height	2U
Weight	15.8 kg / 34.8 lb
Finish	black
Protection rating	IP2X

LA7.16 dimensions

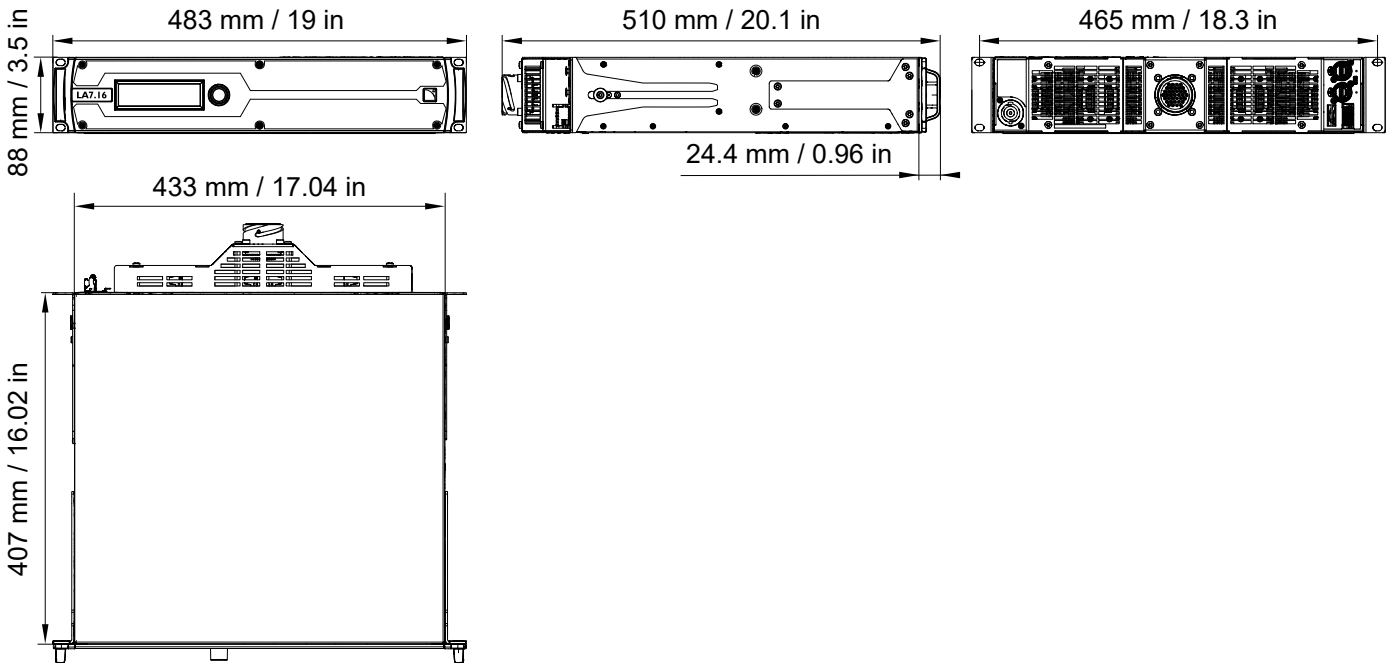

Glossary

CE	Europe
CHK	check procedure
CN	China
D/R	disassembly/reassembly procedure
KR	repair kit
SMPS	Switched Mode Power Supply (power supply inside of the amplified controller)
US	United States

List of AVB reservation (RSV) errors

code	error	resolution
1	Out of bandwidth	<p>There is not enough bandwidth on the path from the talker to the listener.</p> <ul style="list-style-type: none"> • Check that all the bridges in use have a speed of 1 Gb/s (minimum). • Check the configuration of the bridges: some allow a higher bandwidth allocation for AVB streams (default is 75% of link speed). • Change the stream format: select a lower sampling rate, reduce the number of channels if some are unused. • Optimize the stream and channel usage: for each talker, use the minimum number of streams and the maximum number of channels per stream. • Disconnect some of the already connected streams to release bandwidth.
2	Out of bridge resources	<p>One of the bridges on the path from the talker to the listener reached its limits.</p> <ul style="list-style-type: none"> • Try to reboot the bridges on the path from the talker to the listener. • Try to disconnect some streams.
3	Out of bandwidth for traffic class	See error 1.
4	Stream ID used by another talker	<p>A device on the network is behaving incorrectly.</p> <ul style="list-style-type: none"> • Disconnect and reconnect the stream. • Reboot the talker. • Reboot the bridges on the path from the talker to the listener. • If the talker supports manual configuration of the stream parameters, configure the stream to use another Stream ID.
5	Stream dest. addr. already in use	<p>A device on the network is behaving incorrectly.</p> <ul style="list-style-type: none"> • Disconnect and reconnect the stream. • Reboot the talker. • Reboot the bridges on the path from the talker to the listener.
6	Stream preempted by higher rank	<p>An emergency stream has been connected and reclaimed the bandwidth that was used by the Unit stream.</p> <ul style="list-style-type: none"> • Wait until the emergency stream is disconnected (bandwidth is automatically reallocated). • Try the resolutions of error 1.
7	Reported latency has changed	<p>A device on the network is behaving incorrectly.</p> <ul style="list-style-type: none"> • Disconnect and reconnect the stream. • Reboot the talker. • Reboot the bridges on the path from the talker to the listener.
8	Egress port is not AVB capable	<p>Temporarily displayed when a network cable is disconnected then reconnected.</p> <p>If displayed for more than a few seconds, it indicates one of the switches in the network is non-AVB capable, or is configured incorrectly.</p> <ul style="list-style-type: none"> • Only use AVB-capable bridges on the path from the talker to the listener. • If the bridges support configuration of the SR Class priority, configure all the bridges with the same setting (default is 3 for Class A streams).
9	Use a different dest. address	<p>One of the bridges on the path from the talker to the listener has used all of its internal resources.</p> <ul style="list-style-type: none"> • If the talker supports manual configuration of the stream parameters, configure it to use another destination MAC address. • Try to reboot the talker to make it use another MAC address. • Disconnect some already reserved streams.

code	error	resolution
10	Out of MSRP resources	One of the bridges on the path from the talker to the listener has reached its limits. <ul style="list-style-type: none"> • Try to disconnect some streams. • Try to reboot the bridges on the path from the talker to the listener.
11	Out of MMRP resources	One of the bridges on the path from the talker to the listener has reached its limits. <ul style="list-style-type: none"> • Try to disconnect some streams. • Try to reboot the bridges on the path from the talker to the listener.
12	Cannot store dest. addr.	One of the bridges on the path from the talker to the listener has reached its limits. <ul style="list-style-type: none"> • Try to disconnect some streams. • Try to reboot the bridges on the path from the talker to the listener.
13	Req. priority is not an SR class	The talker is behaving incorrectly, or the switches configuration has changed while the stream was active. <ul style="list-style-type: none"> • Disconnect and reconnect the stream. • Reboot the talker.
14	Max frame size too big for media	The talker is behaving incorrectly. <ul style="list-style-type: none"> • Disconnect and reconnect the stream. • Reboot the talker.
15	MSRP fan-in ports limit reached	One of the bridges on the path from the talker to the listener has AVB ports usage limitation and has reached its limits. <ul style="list-style-type: none"> • If possible, change the configuration of the bridges to allow more simultaneous usage of AVB ports. • Review the network cabling to use less ports on the limiting bridge(s).
16	Changed first value for reg. stream ID	A device on the network is behaving incorrectly. <ul style="list-style-type: none"> • Disconnect and reconnect the stream. • Reboot the talker. • Reboot the bridges on the path from the talker to the listener.
17	VLAN blocked on egress port	One of the bridges on the path from the talker to the listener is incorrectly configured. <ul style="list-style-type: none"> • Configure the bridges to allow dynamic VLAN registration. • If possible, configure the talker to use a different VLAN (one that is authorized by the bridges).
18	VLAN tagging off on egress port	One of the bridges on the path from the talker to the listener is incorrectly configured. <ul style="list-style-type: none"> • Configure the bridges to enable VLAN tagging of the egress packets.
19	SR class priority mismatch	A wrongly configured AVB bridge is present in the network. <ul style="list-style-type: none"> • Configure all the bridges with the same setting (default is 3 for Class A streams).

List of AVB connection (CON) errors

code	error	resolution
2	Talker unknown ID	The AVB controller has requested the listener to connect to a talker, specified by an identifier, but that identifier does not exist, or no longer exists. Check that the AVB controller is sending the correct information.
3	Talker dest. mac fail	A listener is trying to connect to a talker while the talker is allocating the destination MAC for the stream. If displayed for more than a few seconds, check for non-Avnu certified devices on the network. Preferably use Avnu-certified devices.
4	Talker no stream index	A third-party talker has an issue allocating an ID to a stream. Refer to the third-party documentation.
5	Talker no bandwidth	The talker cannot deliver all of its streams because a switch on the network does not have enough bandwidth. Use switches with enough bandwidth capabilities.
6	Talker exclusive	A third-party talker that supports a limited number of listeners has reached its limits. Refer to the third-party documentation.
13	Talker misbehaving	The talker has an internal error. Reboot the talker.
16	Controller not authorized	Another AVB controller has locked the talker. Unlock the talker.
17	Incompatible request	The listener is trying to connect to a talker that is already streaming with a different traffic class, or does not support the requested traffic class. If in redundant mode, check the cabling (port 1 must be used for the Primary network and port 2 for the Secondary network).
31	Not supported	Request is unknown to a third-party, non-MILAN compatible talker. Refer to the third-party documentation.

Approvals

LA7.16 is compliant with the following:



Avnu Alliance and the Avnu design mark are registered trademarks and/or service marks of Avnu Alliance.



L-Acoustics

13 rue Levacher Cintrat - 91460 Marcoussis - France
+33 1 69 63 69 63 - info@l-acoustics.com
www.l-acoustics.com

 **L-ACOUSTICS**
GROUP